



Premium
Digitrax Command Control
Starter Set
Users Manual

Includes:

DCS100 Command Station Booster,
DT300 Series Throttles,
IR Operation with UR90, &
Radio Operation with UR91



Digitrax, Inc.
450 Cemetery ST #206
Norcross, GA 30071 USA
(770) 441-7992 Fax (770)441-0759
www.digitrax.com

Digitrax Manuals & Instructions are updated periodically.
Please visit www.digitrax.com for the latest version of all manuals.
This manual was updated 11/02.

Digitrax Chief II Set Users Manual

Includes DT300 Series Throttles, DCS100 Command Station,
IR Operation with UR90 & Radio Operation with UR91

Table of Contents

1.0 Introduction	6
2.0 Chief II Quick Start Guide	7
2.1 Connect the DCS100 to the track & transformer	8
2.2 Plug In Your UP3 Universal Panel or UR91 Radio Receiver	8
2.3 Plug In Your DT300 Series Throttle	8
2.4 Turn track power on	9
2.5 Connect Your Layout To The Chief II	10
2.6 DT300 Display Basics	11
2.7 Select & Run An Analog Loco on Address "00"	12
2.8 Decoder Address Basics	14
2.9 How To Select & Run A DCC Equipped Loco	15
2.10 Shutting Down the System	17
2.11 Resuming your session	17
2.12 Quick Start Problems?	17
3.0 LocoNet: The Digitrax Difference!	18
3.1 System Architecture	18
3.2 Event Driven or Polled?	19
3.3 Network Speed	19
3.4 LocoNet Personal Edition	20
3.5 LocoNet Expansion	20
4.0 Installing Digitrax On Your Layout	22
4.1 Direct Home Wiring vs. Common Rail Wiring	22
4.2 Recommended wire sizes for power bus & track feeders	22
4.3 Other Track Wiring Considerations	23
4.4 Layout Power Districts	23
4.5 Adding a DB150 Booster	24
4.6 Setting Up A Programming Track	25
4.7 Reverse Loop Wiring	26
4.8 Using a DB150 as an AutoReversing Booster	26
4.9 Using PM4 for Power Management & AutoReversing	28
4.10 Using DC and DCC together on the same layout	28
4.11 LocoNet Wiring Components	29
4.12 LocoNet Throttle Jacks	30
4.14 Troubleshooting Layout Wiring	31
5.0 DCS100 Control Panel	33
5.1 Power Input	33
5.1.1 Transformer	33
5.1.2 Heat Dissipation	34
5.2 Power On Indicator	34
5.3 Ground Terminal	34

5.4	RAIL A & RAIL B Terminals	34
5.5	TRACK STATUS Indicator	34
5.6	OFF LINE Indicator	35
5.7	PROG A & B	35
5.8	LocoNet Ports A & B	36
5.9	MODE Switch	36
5.10	SCALE Switch (O/G HO N)	36
5.10.1	Track Voltage Adjustment	36
5.11	DCS100 Audible Sounds	37
5.12	NET Indicator	38
5.13	CONFIG Indicator	38
5.14	DCS100 CMOS Battery Replacement	38
6.0	DT300 Series Throttle Control Panel	39
6.1	General Information	39
6.2	L (Left) & R (Right) Throttle Knobs	40
6.3	Liquid Crystal Display (LCD)	42
6.3.1	Loco Icon	42
6.3.2	Direction Indicators	42
6.3.3	Smoke Icon	42
6.3.4	Mode Indicator	43
6.3.5	L (Left) & R (Right) Throttle Display	44
6.3.6	Text Area	44
6.3.7	L & R Bar Graph	44
6.3.8	Function Display	45
6.3.9	Track Power Indicator	46
6.3.10	Tetherless Indicator	46
6.3.11	L & R Semaphores-Cab Signaling	46
6.4	STOP Key	46
6.5	SEL Key	47
6.6	MODE Key	47
6.7	FN F0 Key	47
6.8	L & R Reverse Keys	47
6.9	Y + & N - Keys	48
6.10	Infrared Emitters	48
7.0	Track Power On/Off	48
7.1	Track Power On	48
7.2	Track Power Off	49
8.0	Lo (Loco) Mode-How To Select and Run Trains	49
8.1	The SEL Message	50
8.2	DCC Address Ranges & Display	50
8.3	Selecting An Address On A Throttle	50
8.4	Recall a Loco	51
8.5	Stealing: Forcing An Address Selection	52
8.5.1	Slot Following	53
8.6	“slot=max” Message	53

9.0	Locomotive Speed Control	54
10.0	Stop	54
10.1	Setting A Loco to Zero Speed	54
10.2	Emergency Stop	54
10.3	Turn Off Track Power	55
11.0	Locomotive Direction Control	55
12.0	Controlling Functions	56
12.1	Controlling F0-F8	56
12.1.1	Function 0 (F0)	56
12.1.2	Function 1, 3, & 4 (F1, F3, F4)	57
12.1.3	Function 2 (F2)	57
12.1.4	Functions 5 through 8 (F5, F6, F7, F8)	57
12.2	Exit Function Mode	58
12.3	Controlling Functions On Consisted Locomotives	58
13.0	Multiple Unit Operations	58
13.1	Adding a Locomotive To A Consist	60
13.2	Removing A Loco From A Consist	61
13.3	Nested Consisting	62
13.4	MU of Mismatched Locomotives	62
14.0	Releasing An Address From A Throttle	62
14.1	Dispatching addresses or consists	63
15.0	Programming and Configuration	64
15.1	Programming Decoder Addresses	64
15.2	How to Program Other Configuration Variables	67
15.2.1	Hex Display & Decimal Display	67
15.2.2	Programming CVs Other Than Addresses	67
15.3	CV29 Configuration Register Programming	69
15.4	Operations Mode Programming	71
15.5	Busy or Fail Message	72
15.6	Reading Back CV Values Programmed	72
16.0	How Your DCS100 Manages 22 or 120 Addresses	74
16.1	22 or 120 “Slots” For Addresses	74
16.2	Address Purging Strategy	75
17.0	Decoder Status	76
17.1	Status Editing a Decoder	77
17.2	Note for Non-Digitrax Decoder Users	77
18.0	Sw (Switch) Mode	78
19.0	Edit Fast Clock & Routes	79
19.1	Fast Clock Basics	79
19.2	Stop the Fast Clock	80
19.3	Edit Fast Clock Time, Rate & Alarm	80
19.4	Route Basics	81
19.4.1	Enabling Routes	82
19.4.2	DS54 Cascaded Routes	82
19.5	Edit Routes	82

20.0 Shut Down and Resume Procedures	85
21.0 Troubleshooting	86
21.1 Clean Track	86
21.2 The Quarter Trick	86
21.3 The LT-1 Tester	86
21.4 Decoder Won't Respond	86
21.5 Emergency Stop	87
21.6 Mechanical Drive Train Problems	87
21.7 "Strange" Locomotive Lights	87
22.0 Troubleshooting Throttle Problems	88
22.1 Emergency Stop	88
22.2 Nothing is responding	88
22.3 Can't select a loco address on my throttle	88
23.0 Tetherless Operation of DT300/R	89
23.1 Power Save Mode	90
23.2 LocoNet ID Change	90
23.3 Tetherless Operation	91
23.3.1 Keyboard Lock	93
24.0 DT300 Battery	93
24.1 Battery Installation	93
24.2 Low Power Indicator	94
24.3 Battery Replacement	95
25.0 Customizing Your DT300	95
25.1 Ballistic or Straight Line Tracking	97
25.2 Fast Clock Display On/Off	97
25.3 Key & Knob Clicks On/Off	97
25.4 STOP Local or Global	97
25.5 Throttle Default Decoder Operation	98
25.6 Tetherless Operation Mode	98
25.7 LCD Backlight Brightness Setting	98
25.8 Fast Clock Format	99
25.9 Recall Stack Depth	99
26.0 DCS100 Option Switch Setup	102
27.0 IR & Radio Receivers UR90 & UR91	107
27.1 Powering UR90 & UR91 Receivers	107
27.1.2 UR90/UR91 Track Status Indicator	108
27.2 Installation Basics UR90 & UR91	110
27.3 UR90 Infrared Receiver Installation	111
27.4 UR91 Radio Receiver Installation	112
27.4.1 Resolving Radio Reception Problems	113
28.0 Multi-Format Operation	114
29.0 Glossary	116
30.0 FCC Information	126
31.0 Warranty and Repair Information	127

Digitrax, Digitrax Train Logos, LocoNet, Empire Builder, Chief, Chief II, Super Chief, Transponding, Zephyr & others are trademarks of Digitrax, Inc. This manual may not be reproduced in any form without the permission of Digitrax, Inc.

Digitrax, Inc. is not responsible for unintentional errors or omissions in this document.

©Digitrax, Inc. All Rights Reserved. Printed in USA REV 11/02

1.0 Introduction

Congratulations on your purchase of a Digitrax Chief II Digital Command Control Set!

The design of the Digitrax Command Control system lets you operate your layout the way you want to. With LocoNet you simply connect system components to build the layout control system that you've always wanted! The Digitrax system reduces and simplifies layout wiring for new layouts. If you already have a layout, you probably won't need to rewire to install Digitrax.

Your Chief II Starter Set has several DCC components:

- The DCS100 is your system's DCC command station. It generates the DCC packets that tell the decoders what to do.
- The DCS100 is also a DCC booster. Boosters receive DCC signals from the command station, amplify them and put them on the track along with the power from the transformer to run the locomotives. You can have several boosters on your layout to provide additional power to run more locos.
- The DT300 or DT300R is the DCC throttle that comes with the Chief II. DCC throttles are the handhelds you use to tell the command station what you want the decoders to do. You will probably have several throttles on your layout if you have more than one person running trains at a time.
- A UP3 Universal Panel or UR91 Radio Receiver for memory walk-around operation or tetherless infrared or radio operation.
- Your Chief II also includes one Digitrax premium mobile decoder. Mobile decoders are installed in the locomotives to control the operation of the motor, lights and other functions of the loco.
- LT-1 LocoNet & Decoder Tester

This manual contains information about running your layout with infrared and/or radio tetherless operation.

There are many different combinations of Digitrax components that you can use to set up a layout control system that is just right for you. You can combine Digitrax products with compatible decoders, boosters and computer software made by other DCC companies.

Your success with and enjoyment of our products are very important to us. After all, this is a hobby and it is FUN!!! Please read this manual carefully before you install your system. We have included lots of hints and operating ideas based on our experience with the Digitrax system. If you have questions not covered by this manual please contact your dealer.



2.0 Chief II Quick Start Guide

These simple instructions will get you up and running quickly. You can investigate the specifics later but, for now let's get your trains running. A full description of all controls and technical reference information are included later in this manual. This section assumes that you are using a new set straight out of the box. If your set is radio equipped, we recommend that you follow this quick start guide without using radio so that you can learn the basics. When you are successfully running your radio throttle tethered to the system, then go to Section 26.0 to learn how to install the radio option.

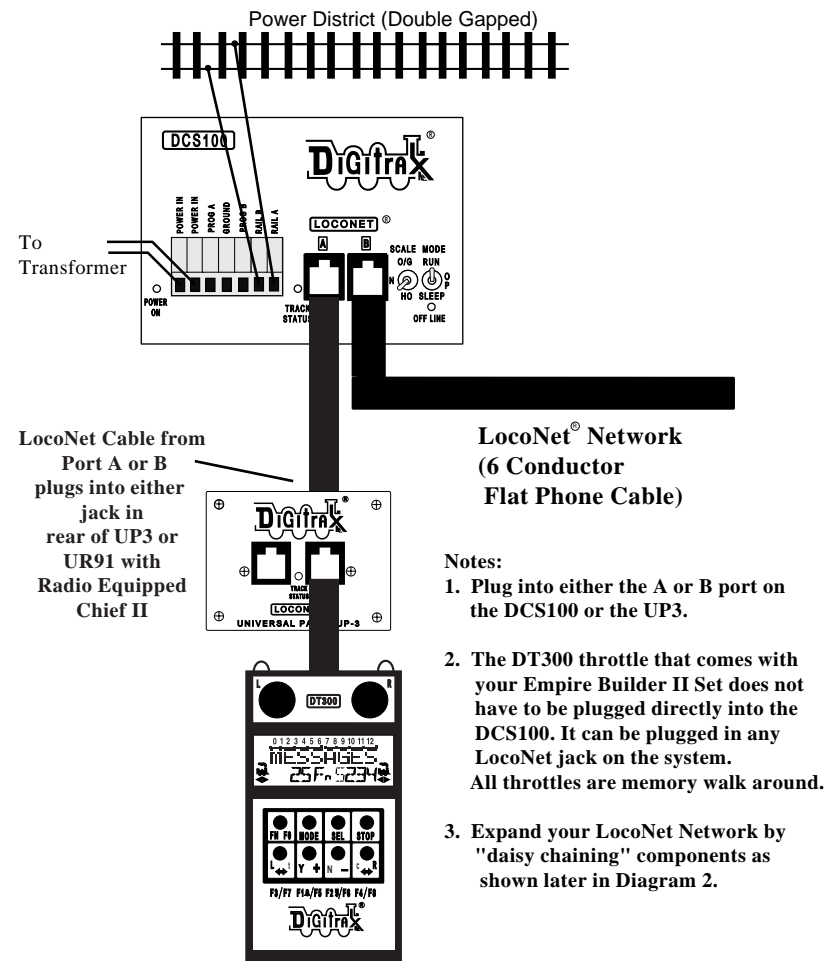
Diagram 1: Chief II Quick Installation Hook Up



2.1 Connect the DCS100 to the track & transformer

1. Set the DCS100's SCALE switch to the scale you are running (N, HO, O(G)).  Use the lowest setting (N, HO, or O/G) that will run your layout.
2. Set the MODE switch on the DCS100 to the RUN position. 
3. Connect the two terminals on the DCS100 marked POWER IN to the transformer.
4. Plug in the transformer to power up your booster.
5. The DCS100 will beep once and its "POWER ON" led will come on.

2.2 Plug In Your UP3 Universal Panel or UR91 Radio Receiver

1. Using the short LocoNet cable provided, connect either of LocoNet jacks on the back of the UP3/UR91 to either the A or B LocoNet Port on the DCS100. If you are using a UR91, plug in the power supply that was included with your radio equipped set. After completing Quick Start, see Section 4.13 & 27 for information about Universal Panel Track Status Lights.
2. If you choose not to hook up the UP3/UR91 during the initial installation, simply plug the DT300 throttle directly into either LocoNet Port A or B on the DCS100.
3. Remember if your set is radio equipped, please follow these quick start instructions in regular walk around mode without radio control. See Section 27.0 for setting up the radio option.

2.3 Plug In Your DT300 Series Throttle

1. Plug the DT300 series throttle into either LocoNet jack on the UP3/UR91 or DCS100.
2. First, you will see the DT300 version number screen:

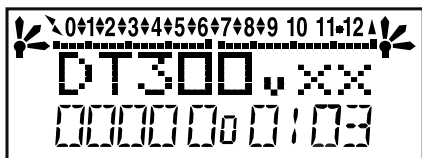

This screen shows the DT300's software version number. It is displayed for a few seconds each time you power on the DT300.

3. Next you will see the power indicator screen:

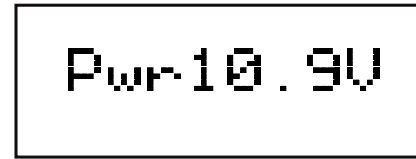

This screen indicates the power available to the throttle. When you are plugged in to LocoNet, this value will be between 9 & 15 volts. when you insert a battery or unplug

from LocoNet, the value displayed will be the battery power available. When this number is less than 6.2 volts it's time to consider replacing or recharging your battery. See Section 24 for more information about using batteries with your DT300.

4. Then you will hear the throttle beep and you will see a screen similar to the following. If your throttle is a DT300R or if there is a UR90 or UR91 connected to your system see Sections 23 & 27 for additional information about radio &/or infrared operation of your throttles.

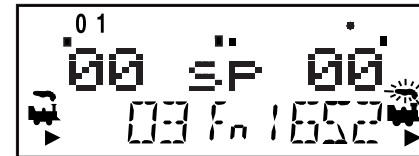

This screen displays current addresses selected on the L & R throttles along with their current speed and direction. The functions that are turned ON for the active throttle (the one with the blinking smoke icon) are displayed across the top of the display.

5. If you unplug the DT300 from LocoNet the LCD will go off while it is unplugged. It will come on again when you plug in to LocoNet again.

2.4 Turn track power on

The track power indicator on your DT300 and track status indicator on your DCS100 command station show whether track power is on or off. The first time you plug in your DT300 throttle, track power will usually be off. Before you can run trains, you will need to turn on the track power. Look at your DCS100 or DT300 to determine whether the track power is on or off.

1. When track power is off:

- DCS100 TRACK STATUS indicator is off,
- DCS100 OFF LINE indicator is on, and
- DT300 Track Power Indicator is off (track power indicator is a small dot in the top line on the right side of the LCD).

2. When track power is on



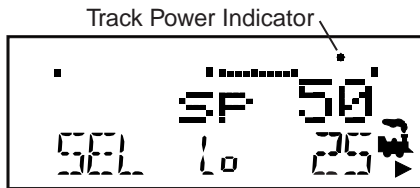



- DCS100 TRACK STATUS indicator is lit,
- DCS100 OFF LINE indicator is off, and
- DT300's Track Power Indicator is on
(small dot in the top line on the right side of the LCD).



This display shows a DT300 with.

1. Track power is currently on-indicator illuminated.
2. The L throttle does not have a loco selected-SEL in lower L side of display.
3. The R throttle is running address 25 in the forward direction at 50% speed-25, train, smoke & direction arrow in lower R side of display.
4. Press and hold the STOP Key followed by the N- key to turn track power off and you will see the Track Power Indicator go off.

How To Turn Track Power On and Off

1. **Turn track power on:** Press and hold the STOP Key  (like a shift key on a keyboard) then press the Y + Key  while continuing to hold the STOP Key . Release both keys when the Track Status/Power Indicators on the DCS100 & DT300 come on.
2. **Turn track power off:** Press and hold the STOP Key  then press the N - Key  while continuing to hold the STOP Key . Release both keys when the Track Status/Power Indicators on the DCS100 and DT300 go off.





2.5 Connect Your Layout To The Chief II

1. Be sure both the DCS100 TRACK STATUS indicator and POWER ON indicators are lit.
2. Connect the DCS100's RAIL A and RAIL B terminals to your track. Connect RAIL A to one rail and RAIL B to the other rail.
3. If you don't hear any beeps when you connect the DCS100 to your layout, no short circuits have been detected. To be sure that the

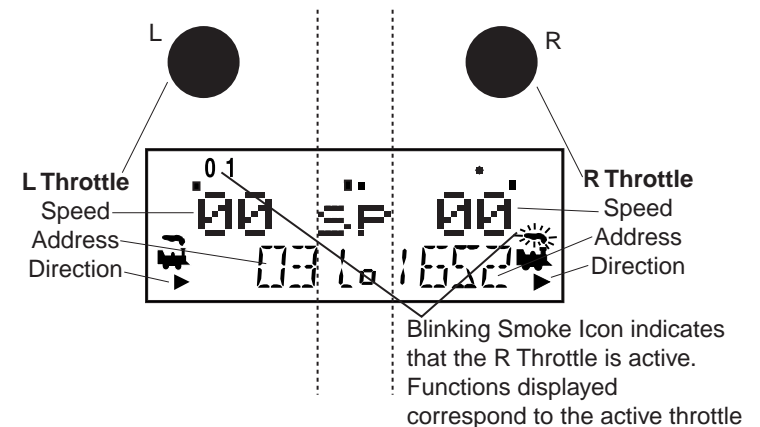
DCC signal is available everywhere on the layout, use a screwdriver blade or a coin across the rails to cause a short circuit. You will hear the 4 beeps and the DCS100 will shut down. Remove the short and the DCS100 will resume normal operation. Try this at several places around the layout to confirm that the signal is getting through. If the short you create does not shut down the DCS100, review your wiring in that area of the layout to be sure you have enough track feeders to supply power and signal to the track. Since the DCC signal travels with the power on the rails, it is important to have power to the track in all locations so that the decoders can see the signal and respond to your commands.

2.6 DT300 Display Basics



1. The DT300 handheld has two throttles called the left throttle (L) and the right throttle (R).
2. There are two direction indicators  on the DT300. One for the L throttle and one for the R Throttle. If the direction indicator is lit, and there is smoke over the loco icon  there is an address selected on that throttle. The direction indicator with blinking smoke  indicates which throttle (L or R) is currently active. the active throttle is the one for which function and text information is currently displayed on the LCD screen.
3. The direction indicator shows the direction of travel of a DCC equipped loco selected on that throttle,  for reverse and  for

forward. If you are running an analog loco, the direction indicator will only indicate change in track polarity and will not necessarily match the direction of travel of an analog loco.

4. The current mode of operation is shown in center of the bottom line of the display. The normal operating mode is Lo or Loco Mode for running trains. In this mode, you can either turn the throttle knobs or use the Y+ & N- Keys to increase or decrease speed.. You can use the FN F0 Key and other keys associated with functions to change function states.

For example, in Lo mode, to increase speed you can either turn the throttle knob clockwise or press the Y + Key. To change the loco's direction you can either double click the throttle knob or you can press the reverse key associated with the throttle you are using. To access functions on the active address you are controlling, simply press Fn Key followed by the key associated with the function you wish to activate or deactivate. As long as the Function mode is active Fn will appear in the center of the bottom row of the display.

The following examples will help you learn about your new DT300. The first example shows how to select and run an analog loco, the second example shows how to select and run a DCC equipped locomotive. Once both locos are selected on your throttle, you can run them both at the same time on DCC.

2.7 Select & Run An Analog Loco on Address "00"

1. Place an analog locomotive (one without a decoder) on your layout. While the analog loco is sitting still, you will hear the characteristic "singing" caused by the DCC track signal when it is applied to analog locomotives. Once the analog loco is moving, this sound will change and be less noticeable. (Digitrax recommends that analog locos not be left sitting on DCC powered track for long periods of time when they are not running.)
2. Check the track power indicator on your DT300's LCD to be sure that track power is turned on.
3. Activate the DT300's right throttle knob "R" by turning it a 1/4 turn in either direction or by pressing down on the R Throttle knob once. If there is nothing selected on the R throttle, "SEL" will flash on the lower right of the LCD. If an address is selected on the R throttle, the smoke above the loco will begin to flash indicating that the R throttle is active.

If there were no locos selected when you began step 4, you will see the following in your display:

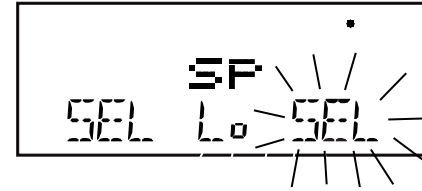



If locos were previously selected, you will see the smoke icon above the loco icon begin blinking on the R side of the throttle, indicating that the R side is now active.

4. Press the SEL Key . The LCD will show the last address used blinking on the R Throttle. Use the R Throttle knob to dial in "00" in the R Address display.

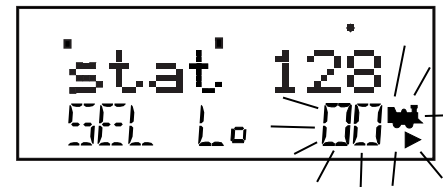
The display will show the current decoder status of the addresses as you browse through them. Decoder status is discussed later in section 17. You will see a screen similar to this one:



5. Press the SEL Key again to select address 00 on the R throttle. The  icon and the address will be blinking for about 6 seconds. If no other buttons are pressed, after the 6 seconds the throttle will time out and return to "SEL". If the throttle times out, just press the SEL

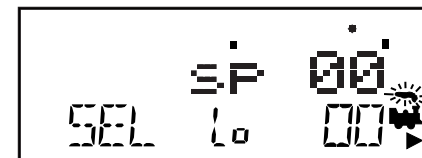

Key  again to return to the selection process. When address 00 is selected on your throttle you will see a screen similar to the following which shows address 00 on the R Throttle at 0 speed.

Note: When running an analog loco on address 00, the direction indicator in the LCD **does not** indicate the direction of travel of the locomotive.



6. Turn the R Throttle Knob clockwise slowly to 99% speed. The DCS100 TRACK STATUS indicator should change color as you change the speed setting.

7. Press the R Reverse Key  on the right side of the DT300. The R

direction indicator will toggle between  and . The indicator will change each time you press the direction key. Note: Double clicking the R Throttle knob will have the same effect as the R Reverse Key. To double click, press down on the throttle knob twice within about 1/2 second.

8. Once you complete these observations successfully, turn the right throttle knob counter clockwise to 0% speed.

9. Place an analog locomotive on the track. While the analog loco is sitting still, you will hear the characteristic “singing” caused by the DCC track signal when it is applied to analog locomotives. Once the analog loco is moving, this sound will change and be less noticeable.

10. Turn the R Throttle knob clockwise to increase the speed of the analog locomotive. As the speed increases, the locomotive on the track

will begin to move. Press the R Reverse Key  or double click the R throttle knob to reverse the direction of the analog locomotive.

11. Turn the R Throttle knob counterclockwise to 0% speed to stop the analog loco.

2.8 Decoder Address Basics

Each DCC decoder has an address that is used by the system to send commands to that decoder. To select a DCC locomotive and run it on either throttle, you must know its address. Digitrax decoders are set up at the factory with the “default” digital address of 03. This means that when you take a Digitrax decoder out of the package and install it in your loco, you can select address 03 on your throttle & run the decoder. The first CV programmed by most DCC users is the decoder’s address since it is not very useful to have all of your locos run on address “03.” If you do not know the address of the DCC locomotive you want to run, simply program the decoder’s address and select it to run using its newly programmed address. Some DCC command stations like the DCS100, can read back the address of a decoder. See your Digitrax Decoder Users Manual for a complete discussion of decoder addressing.

2.9 How To Select & Run A DCC Equipped Loco

1. Activate the DT300’s left throttle knob “L” by turning it a 1/4 turn in either direction or by clicking the L throttle knob once. If no address has been selected on this throttle it will flash “SEL” (as shown below) or the last address selected on the L throttle knob.



The illustration above shows the LCD display just after you press the SEL Key to select an address on the L throttle when nothing has been selected on that throttle before and where address “00” is selected to run on the R throttle.

2. Press the SEL Key . If an address was selected previously, you will see a screen similar to the following indicating the last address used on this throttle and its decoder status:

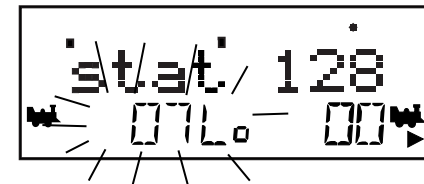

The illustration above shows the LCD display after you have begun browsing for a new address to select on the L throttle. In this case address “07” is displayed along with its current decoder status in the system “stat 128” See section 17 for more information on decoder status.

3. Use the R Throttle knob to select Address “03” in the left display. (The R Throttle knob changes 1s and 10s, The L Throttle knob changes 100s and 1000s.)

4. Press the SEL Key  to select address 03 on the L throttle.

5. The left loco icon will appear in the display with a direction arrow

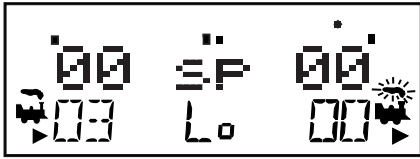

and “blinking smoke” . The “blinking smoke” indicates which side of the throttle is displaying function information on the top line of the LCD.



The illustration above shows the LCD display after address "00" is selected on the R Throttle and address "03" is selected on the L Throttle. We see the Track power indicator "on" in the top line, the speed bar graphs at 0 speed and the text area also at 0 speed for both throttles.

6. Use the L Throttle knob to run the DCC equipped locomotive on address 03. As the value in the left display increases, the locomotive with decoder address 03 on the track will begin to move. Press the L Reverse Key  on the left side of the DT300 or double click the L Throttle Knob to reverse the direction of the locomotive.

7. Turn the L Throttle knob counterclockwise to 0 speed to stop the locomotive.

8. Use the R Throttle knob and R Reverse Key  to control the analog loco and the L Throttle knob and L Reverse Key  to control the DCC equipped loco. You can control both at the same time.

Throttle in normal operations mode indicated by Lo.
 In Loco (Lo) Mode Throttle knobs control Loco's Speed & Direction
 Functions controlled by FN & Associated Key

Track Power Indicator ON

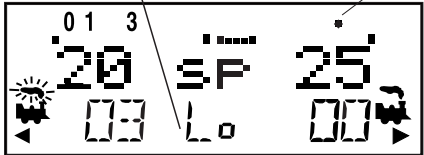

2 digit address 03 Selected on the L Throttle Running at 20% speed In reverse Function 0, 1, & 3 on.

An analog loco address 00 Selected on the R Throttle Running at 25% speed The direction arrow below the Loco Icon **does not** indicate actual direction for Analog locos.

Notice as you use each throttle knob or direction key that the loco with the "blinking smoke" will change to that side of the throttle. The side with the "blinking smoke" indicator is the active throttle. To

control the headlight or other functions, the locomotive must be on the active throttle.

By now you are running two locomotives (one analog and one DCC) and you have learned some of the key concepts of using the DT300! Please read the following sections for more in depth information about other features & capabilities of the Chief II set.

2.10 Shutting Down the System



When you are finished with your session, stop all of your locomotives by setting the throttles to zero speed and turn off power to the system. Once you begin using your system with more locos, you should read Section 14 to learn how to release addresses from each throttle before shutting down. This is a housekeeping measure that can help avoid "strange operation" caused by throttles running locos that you might have forgotten were selected in the system when you last shut it down.

2.11 Resuming your session

When you are ready to resume your session:

1. Turn on the power to the system.

2. Be sure the DCS100's MODE switch is in the "RUN" position .  All attached throttles will beep within a couple of seconds to indicate that LocoNet is active again.

3. Check the track status indicator on the DCS100. If it is not lit then press and hold the STOP Key  followed by the Y+ Key  on the DT300. Release both keys when the DCS100's track status indicator comes on. This will turn track power on.

2.12 Quick Start Problems?

If you encountered problems at any step in this Quick Start Section: First, try backing up a step until you get results described. The steps included in this installation procedure are set up so that if you follow them carefully, any problems you encounter will be easy to isolate & debug.

If that does not work or if you have other questions or problems, we encourage you to call, fax or e-mail your favorite Digitrax dealer. If your dealer is not able to help, please contact Digitrax directly.

There are thousands of successful Digitrax installations around the world and we want to be sure that yours is one of them.

QUICK INSTALLATION Notes for users of Digitrax decoders that have already been programmed and decoders not made by Digitrax:

1. The DCS100 command station defaults to 128 speed step operation so, if you are using a locomotive with a decoder that does not have 128 step capability you will have to adjust either the decoder or the DCS100 command station so that both are using the same number of speed steps to communicate. You can status edit each individual decoder (see Section 17.0) or you can change the DCS100's system default and run all of your decoders with fewer speed steps to accommodate these decoders (see Section 26.0).
2. If you can't control the operation of the lights in your decoder equipped locomotive with the DT300 (in default 128, or 28 speed step mode), be sure that the decoder itself is programmed in advanced 28 speed step mode. Please refer to Section 17.0 for corrective measures.

What's Next?

Now that you have successfully set up your Chief II Set, it's time to learn more about the features and options offered by Digitrax and the LocoNet system. Read the manual and take time to understand and master each topic. Your Chief II Set is the gateway to all the possibilities and options offered by Digitrax so the best advice is to take it step by step and don't try to do everything at once. The Digitrax Big Book of DCC is another excellent resource available to you as you expand your layout. The Big Book is full of examples that show you how you can have even more fun with your layout.

3.0 LocoNet: The Digitrax Difference!



3.1 System Architecture

System Architecture is the biggest difference among DCC systems. System architecture is the way the components of a DCC system communicate among themselves. Digitrax LocoNet is a Peer to Peer local area network (LAN) designed specifically for model railroad operation. LocoNet wiring is cost effective,

flexible and expandable to accommodate almost anything you want to do with your railroad today and in the future.

The system architecture used for communication within DCC systems is not standardized therefore, DCC compatibility encompasses decoders, command stations and boosters but not throttles and other devices. In addition, devices that require feedback and other types of signals that are outside the domain of DCC, such as detection systems and transponding, are not standardized. LocoNet incorporates both DCC and other technologies that expand the capabilities of your system. Your Digitrax system gives you the best of both worlds

with a system that is compatible with today's DCC standards and also goes beyond those standards to deliver enhanced system performance, multi-format capabilities and advanced features that are far beyond the scope of DCC.

3.2 Event Driven or Polled?

LocoNet is an event driven network. The command station on LocoNet waits for input from other components before sending commands to the layout. For example, if there are 10 throttles on LocoNet and throttle #1 sends a command, the command station sees it and executes immediately. With a distributed network like LocoNet, new features can be added by simply plugging in new hardware or software. Since LocoNet is a peer to peer network, devices on LocoNet can act independently of the command station, too. Feedback is incorporated in LocoNet's communication scheme so you don't need to wire a separate feedback bus.

Other DCC systems typically use polled buses or "networks." In this case, the command station must "ask" each of the throttles or other devices in turn: "Do you have input for me?" The device must wait for the command station to poll all the devices on the bus before it sends the command. This arrangement can slow down response times and limit the number of devices that can be handled by the system as more and more devices are added. With centralized processing in a master/slave control type system like this, adding new features usually means updating the command station software when new components are added since devices can't operate on the system unless the master command station knows how to handle them. To add feedback capabilities to this type of system, a separate feedback bus may also be necessary.

3.3 Network Speed

Is faster network speed better? Not necessarily, it depends on whether the system uses event driven or polled architecture. The NMRA's track control packet format sets the "speed limit" for all DCC systems. Going faster than the "speed limit" won't make a system work any better & causes signal distortion problems on the network.

LocoNet is engineered for the lowest speed that will get the job done. Because LocoNet is event driven, slower network speeds are possible. With slower network speed, signal distortion on the network is not a problem. Because LocoNet uses a slower network speed, its free-form wiring scheme is simple and flexible. With LocoNet you can "branch" or "tee" anywhere in your network wiring and no termination is needed.

Polled systems generally have to go a lot faster than the "speed limit" to accommodate the large amount of traffic generated by polling and to prevent

delays between the time a command is issued by the throttle and the time the system executes the command. The big problem is that as the network speed increases, so does signal distortion. Polled systems generally use linear terminated bus wiring to solve this problem. Free-form wiring like LocoNet is not usually possible with polled systems.

3.4 LocoNet Personal Edition

LocoNet Personal Edition is available to all model railroaders through our web site. This edition of LocoNet is available so that you can develop your own private LocoNet applications.

3.5 LocoNet Expansion

Diagram 2 shows some of the expansion possibilities available with LocoNet. This diagram is an extension of the Empire Builder Diagram 1. With LocoNet you can add:

- More boosters to give you more power to let you run more trains,
- More throttles for more operators,
- Different types of throttles,
- More throttle jacks for convenient walkaround operation,
- Infrared or radio capability for more freedom for operators,
- Accessory decoders for turnout and accessory control,
- Detection,
- Transponding,
- Signaling,
- A personal computer to automate operations or for dispatching,
- Automatic reversing with a booster or power manager,
- The list goes on and on.

With LocoNet, you customize your layout to run the way you want it to run!

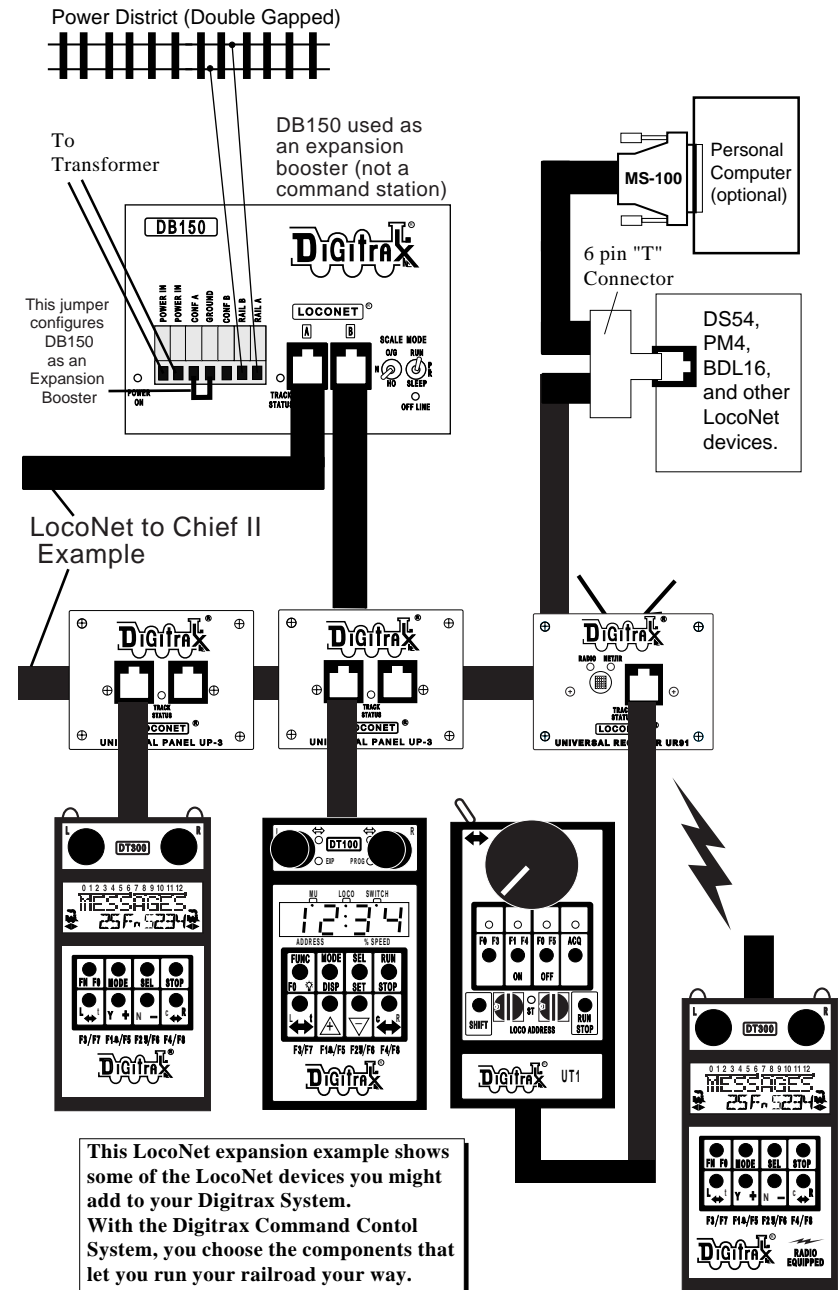

Diagram 2: LocoNet expansion example

4.0 Installing Digitrax On Your Layout

Early proponents of DCC touted the fact that you can hook up your railroad with just two wires. While this is technically correct, there are some things you will need to consider to get the most out of Digitrax Command Control.

Because the DCC signal and the power that runs the trains are one in the same, you must provide adequate power to all areas of your layout for reliable DCC operation. If the decoder in the locomotive does not see track power, it will not see the DCC signal and it won't run. Digitrax boosters need enough track power to sense short circuits to operate properly. Your layout must have a power bus and feeder system that can safely support the continuous full current rating of any booster anywhere on the layout.

The good news is that if your current layout runs with regular DC then it will probably run on DCC. Unless you need to set up power districts on your layout for added power, the only gaps you need are for hard shorts like reverse loops & uninsulated frogs. If you are already wired for block control, you probably don't need to rewire. Just open all your blocks so that the entire track has power & you are ready to go. If you are using common rail wiring, we recommend that you divide the layout into power districts by double gapping between power districts.

4.1 Direct Home Wiring vs. Common Rail Wiring

Digitrax strongly recommends direct home wiring where each power district and its booster are electrically isolated. This type of wiring is safer and more convenient to work with for debugging and for adding reversing sections and detection later. *If you are planning to use whole layout common rail wiring, please have your dealer special order opto-isolated boosters for your layout.* Note for detection and signaling wiring common rail can be used within power districts that are wired for direct home and use regular Digitrax boosters.

Remember, no matter how you control your trains, you should always use safe wiring practices.

4.2 Recommended wire sizes for power bus & track feeders

On an average size layout Digitrax recommends that the power bus from the booster be at least 16AWG. When feeding areas up to 50' from the booster, we recommend using 12 AWG wire for the power bus. From the main power bus, we recommend dropping feeders (22-24AWG) approximately every 6 to 10 feet of track. Sets of feeders should be wired to both rails and we recommend at least 2 sets of

feeders per power district.

The actual wire gauges used (AWG) can be increased or decreased, depending on your actual layout dimensions and operating power/current loads.

4.3 Other Track Wiring Considerations

1. Power connections to a large layout should be via a parallel conductor power bus similar to that used in most conventional layouts, with feeder wires to the track about every 6-10 feet.
2. When using more than one booster, be sure that the Rail A and Rail B connections for all boosters are made in the same track orientation, i.e. Rail A to left rail and Rail B to right rail or vice versa.
3. Do not short either the Rail A or Rail B output of the DCS100 to Ground.
4. To minimize the possibility of radio interference, twist all conductors.
5. Circulating ground loops may cause problems with your DCC layout. We often see this on existing layouts that have been added on to over the years. If you are experiencing problems in a localized area of your layout, you may need to look for this problem and fix it.
6. Wire the power feeds away from the boosters and command stations, in a radial "star like" configuration to minimize the possibility of creating "magnetic induction" loops.
7. Do not place ANY filters or capacitors across the track. These will short out the DCC signals. Be sure that no capacitors are bridging your DCC power districts.

4.4 Layout Power Districts

A DCC power district is an electrically isolated section of the layout including the power wiring, DCC booster and power supply that drives it. Power districts are used for power distribution, not for train control as with DC blocks. Power districts may be divided into sub-districts for short circuit management within the power district or for auto reversing. Even though blocking is not required for train operation with DCC, dividing the layout up into power districts (and sub-districts) may be needed:

1. Additional power districts may be needed to provide enough power to operate more locomotives than one power supply alone can handle. For example a 5 amp booster and power supply will operate between 10 and 15 average N-scale locomotives and between 6 and 10 HO locomotives. If you wish to run more locos on your layout, then you will need to set up more power districts to provide more total power.

- Additional power districts and sub-districts can be used to prevent the whole layout from shutting down when short circuits (like de-rails or an operator running a switch) occur in any given power district or sub-district. If a short occurs in one district or sub-district, only that area of the layout shuts down, the rest of the layout keeps operating.

To set up power districts and sub-districts on your layout:

- Determine how you want to arrange power districts and sub-districts.
- Double gap the rails at each end of the power district and single gap for sub-districts within districts.
- Connect a DCS100 or other Digitrax booster and power supply to each district. Use a PM4 with your DCS100s to set up sub-districts.
- Connect the DCS100 or other Digitrax boosters to the command station via LocoNet.

How can I be sure I have enough power to run my trains? Use the “quarter trick.” Once your Digitrax booster is installed and the layout is powered up, use a quarter (or other piece of conductive material) to short both rails at various places on the layout. If you have enough power at that location, the booster will chirp and shut down. If the booster does not shut down, then you need to add more feeders.

4.5 Adding a DB150 Booster

Your DCS100 is a command station and booster in one unit. The DCS100 is not intended to be used as a booster only. When you are ready to expand your Chief II Set, we recommend that you add a DB150 Booster. Be sure that you follow the directions below when you add DB150s to your system so that they are set up to run as boosters. See section 4.7 below for information about setting up your DB150 as an auto-reversing booster.

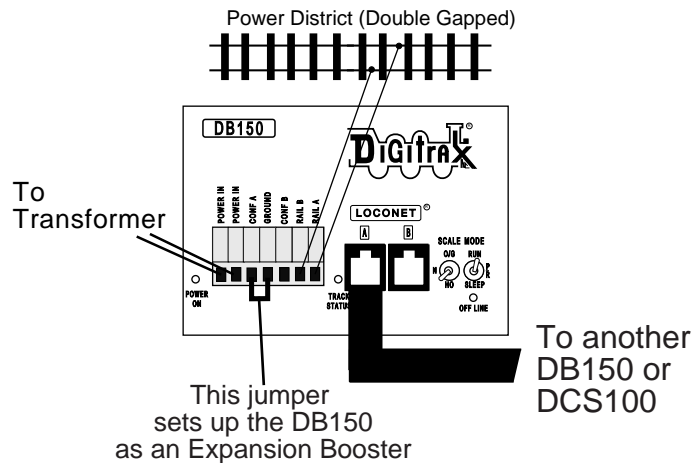

To Install an additional DB150 Booster on your system:

1. Start with an un-powered DB150.
2. Connect the DB150's CONFIG A & GROUND terminals with a short length of wire



3. Set the DB150's MODE switch to RUN
4. Power up the DB150. The DB150 will automatically convert to booster only operation when you power it up.
5. Connect the DB150 to your DCS100 on LocoNet via either LocoNet Port A or B using regular LocoNet Cables that have been tested with the LT1.
6. You can add more DB150s by “daisy chaining” additional DB150 boosters via the LocoNet Port A or B on any DB150 in the system.

If you experience problems with operation after you add a DB150 to your system, check to be sure that you have actually set it up as a booster by going through the steps above again. We have seen this simple mistake cause operating problems with modular layouts when someone added a DB150 set up as a command station to a layout that was already up and running with another command station (DCS100 or DB150). In this case, two command stations can be trying to run the same layout causing some undesirable operating results such as trains that appear to be running away.

4.6 Setting Up A Programming Track

Decoders are programmed when the command station sends programming information to them through the rails. Your DCS100 sends these commands using the PROG A & PROG B outputs. See Diagram 3 for hook up information. PROG A & PROG B are actually a second set of DCC outputs that allow you to program decoders while still running the layout on the RAIL A & RAIL B outputs. You will need to set up a programming track for service mode programming but you will not have to shut down the rest of the layout during programming. Follow the steps outlined in Section 15.0 to program your DCC equipped locomotives:

There are two ways of programming decoders.

Service mode programming broadcasts a message to all DCC equipped locos that are on the track. Because this is a broadcast method, you will need to set up a programming track so that the programming instructions only go to the loco you want to program. Decoder addresses can only be programmed using service mode programming. Service mode is also used to program all other CVs, too.

Ops mode programming is done on the layout with programming directed to a specific decoder address. Operations mode programming is used to make changes other than address to locos while they are running on the layout.

Diagram 3: Programming Track With DCS100

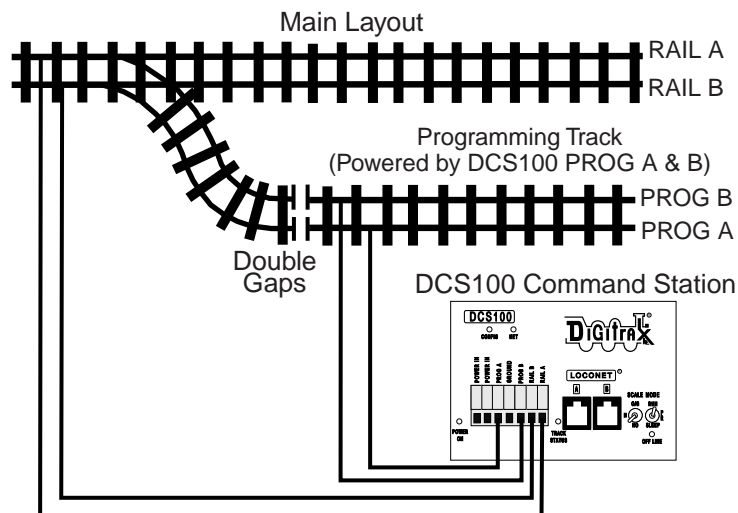

NOTE: Some wiring omitted for clarity

4.7 Reverse Loop Wiring

You can operate reversing sections manually or automatically with Digitrax. You must double gap (completely isolate) both ends of the reversing section just like with any other layout.

If you choose manual operation, use a DPDT switch or relay to handle the polarity change as the loco enters & leaves the reversing section.

If you choose to use a DB150 auto reversing booster to completely automate the reversing section, power the reverse loop with a DB150 and transformer and the main layout with your DCS100 & transformer. The DCS100 when running as your command station will not auto-reverse.

4.8 Using a DB150 as an AutoReversing Booster

1. Start with an un-powered DCS100.
2. Connect the DB150's CONFIG A, CONFIG B & GROUND terminals with two short lengths of wire.

3. Set the DB150's MODE switch to RUN .
4. Power up the DB150. The DB150 will automatically convert to automatic reversing booster operation when you power it up.
5. Connect to your DCS100 or other DB150s on LocoNet via either LocoNet Port A or B using LocoNet Cables that were tested with an LT-1.

Diagram 4: Automatic Reversing Section Set-Up



Note: Some wiring omitted for clarity

If you are using a DB100 series booster as an auto reversing booster consult the appropriate manual for the correct hook up procedures.

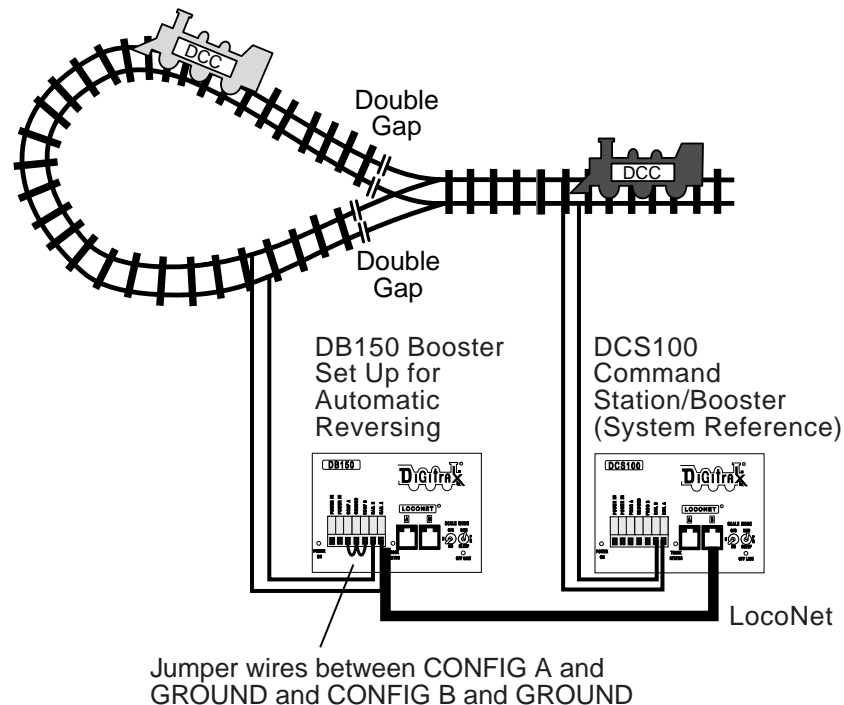
Note that when the polarity change occurs, DCC equipped locomotives will continue at the speed & in the direction commanded but any analog engines running will reverse direction because they see the polarity change and respond to it.

To handle auto reversing, you will need two devices, one that acts as the

system polarity reference and another to detect a polarity mismatch and correct it. If you are using two Digitrax boosters, one acts as the polarity reference and the other handles the polarity reversal for the reversing section. You can also use a DCS100 and PM4 to handle automatic reversing sections.

A single DB150 can be used to handle more than one reverse section however, the unit can only fix a polarity mis-match at one gap at a time. If more than one train is entering or leaving the reverse loops connected to a single booster at the same time, a short will occur. More than one train can be in the reverse loop at any time but, only one can cross the double gap at a time.

4.9 Using PM4 for Power Management & AutoReversing

If you want the benefits of setting up power districts on your layout but you don't need to add more power to run more trains, you can use a PM4 Quad Power Manager to set up sub-districts within booster power districts. With PM4 you can separate the output of one or more boosters into four sub-districts that can be set up as either auto-reversing or as smart circuit breakers for short circuit management.. For more information about this option, contact your Digitrax dealer or check our web site at www.digitrax.com.

4.10 Using DC and DCC together on the same layout

When running between DCC track sections and adjacent conventional DC powered tracks, both rails must have insulating gaps.

The DC supply used must have some form of current control. A 5 to 10 Watt 12 Volt lamp placed in series with one of the DC power pack track leads will work for this purpose. This allows the DCC booster to drive the locomotive onto the DC track with minimum interruption and stress to the booster, decoders and locomotive wheels. When the lamp lights as the locomotive bridges the gaps it acts as a "shock absorber" between the DCC and DC track sections. It is best to cross these gaps quickly and not bridge the DCC and DC sections for any longer than necessary.

Some new Digitrax users believe it is very important to be able to switch between DC & DCC operation as they make the change from DC to DCC. In practice we find that most of these customers make the change much sooner than originally planned because of the operational benefits of DCC.

4.11 LocoNet Wiring Components

The RJ12 is the 6 pin version of the RJ11 connector with all 6 pins loaded with conductors. This is the connector Digitrax uses for LocoNet.

Making your own LocoNet Cables is simple and cost effective. We recommend that you invest in a good quality set of crimpers. We also recommend that you use the LT-1 tester that came with your Chief II to test the cables to be certain they are good before installing them. Many layout problems we see are related to LocoNet cables that were not built or crimped correctly.

Testing LocoNet Cables with an LT-1

1. Disconnect the wire harness from the LT-1.
2. Plug one end of the LocoNet cable being tested into the LT-1.
3. Connect the other end to any powered Digitrax booster LocoNet Port A or B. **Be sure you have at least one Digitrax throttle connected to LocoNet.**
4. All four LEDs on the LT-1 will light if the cable is good. LEDs may not all be the same brightness, this is normal. NOTE: Only three leds will light if no LocoNet throttle is plugged in to the system.
5. If any of the leds fail to light, recrimp the plugs on the LocoNet cable and retest.

LocoNet typically supports a total cable length of up to 2,000 feet with no two devices connected by more than 600 feet of cable. LocoNet wiring is totally free-form. We do not recommend looping LocoNet back on itself.

For all LocoNet cables and connections we use the following wiring convention:

Pin #	Wire Color	Name
1	White	Rail Sync
2	Black	Ground
3	Red	LocoNet
4	Green	LocoNet
5	Yellow	Ground
6	Blue	Rail Sync

LocoNet cables are wired pin 1 to pin 1. When you hold the plug with the tab up and look into the end of the connector you will see the wires listed above starting at the left side and moving to the right. (this is sometimes called a "reversing cable" in the telecom industry even though it really does not reverse).



Most Digitrax dealers can supply or tell you where you can get the cable, plugs and crimpers you will need. Mail order electronic suppliers also have these components available.

4.12 LocoNet Throttle Jacks

All Digitrax throttles are memory walkaround throttles, some are equipped with infrared leds and others are radio throttles. Even if you use wireless throttles, you will still need to install at least one or two LocoNet throttle jacks on your layout. Any RJ12 6 conductor phone jack can serve as a LocoNet throttle jack. The problem with using RJ12 telephone style jacks is that you will have to wire them and secure them to the layout so that they don't come loose. The Digitrax Universal Panel UP-3, included with your Chief II Set, provides a simple plug and play alternative to wiring RJ12 telephone style jacks around the layout. This fascia mounted panel provides 2 RJ12 jacks as well as "Track Status" indicator. The back of the panel provides 2 RJ12 jacks for daisy chaining to the next LocoNet device on the network. The UP3 also provides a professionally finished look to your layout fascia. Universal panels are shipped without front fascia panels attached. Simply use the screws provided to attach this panel to the PC board as shown above.

Diagram 5: UP3 Assembly & Hook-up

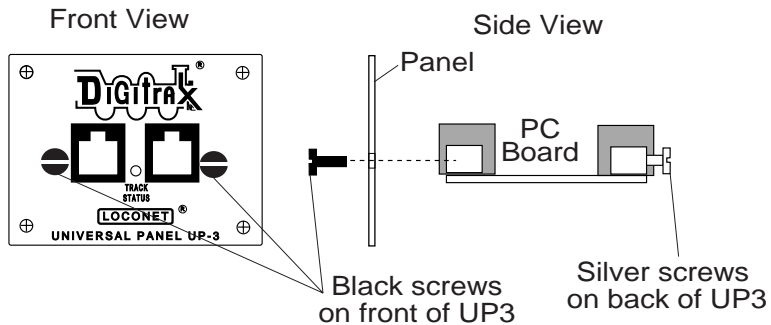

The diagram below shows how to hook up your UP panel on your layout. Instructions are also included below for hooking up the track status indicator. This is an optional feature and the UPs will work just fine even if you do not hook up the track status indicator to the local track section.

Using one or more UR90, UR91, or UP3 with a single external DC power supply

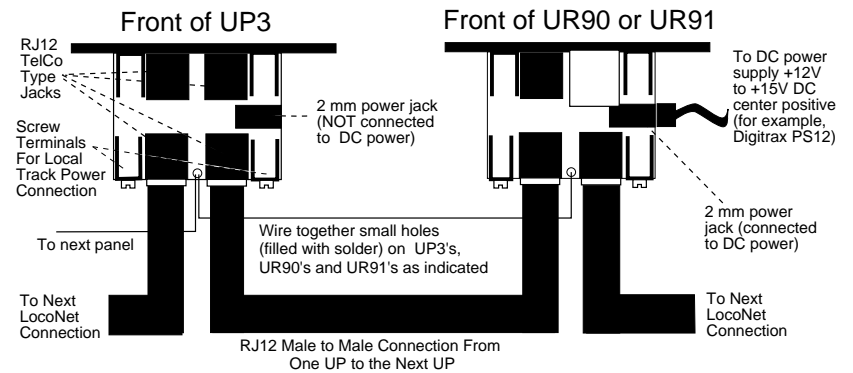

Note: You can run up to 10 UP or UR panels with a single DC power supply by simply connecting the small holes on each panel as indicated in this diagram.

Hooking up the UP/UR's Track Status Indicators-Optional

The UP3's, UR90's & UR91's Track Status Indicators are bi-color LEDs that show the status of the local track section to which it is attached. To hook up the track status indicator follow these steps:

1. Attach an 18-26AWG wire to one of the screw terminals on the back of the UP/UR & connect the other end to either rail.
2. Attach another 18-26AWG wire to the other screw terminal on the UP/UR & connect it to the other rail of the track.
3. If you are hooking up more than one UP/UR, be consistent in hooking up all track sections alike with respect to which terminal is connected to which rail. This is not required but strongly recommended.

As you operate your layout, the UP/UR Track Status Indicator will be lit when the track is powered. The LED glows red or green when you are operating an analog locomotive and the system is "zero stretching." When you are using DCC only, the LED will glow orange. This color change is a useful diagnostic tool.

4.14 Troubleshooting Layout Wiring

Installing Digitrax, or any other command control system, on your layout will not fix problems with layout wiring. Layout wiring can be very complex. We see many examples of layouts that have "grown over the years" where wiring was added and changed creating some very interesting electrical systems. If you suspect that layout wiring might be a problem, we recommend that you

disconnect the Digitrax equipment from the layout and test it on a small section of track not connected to the layout to confirm that the problem is not with your Digitrax equipment. If you find that there is a problem with your Digitrax equipment, contact Digitrax tech support. If you find that your Digitrax equipment is working fine, then it is time to de-bug the layout.

Observe the problem carefully and methodically.

Does it occur with both DC and DCC operation? If so, check track wiring.

Is it occurring everywhere on the layout or in one particular area?

With your Digitrax system hooked up, use the coin trick described in Section 4.4. You may not have enough feeders or your power supply may not be adequate. Use your LT-1 to test the LocoNet cables attached to the booster in the problem area.

Does it only occur with certain locomotives? Check the locomotives for mechanical problems and for damaged decoders. If you programmed the decoders just before the problem started, go back and re-program them in case you entered values by mistake that are causing the problem.

Does it only occur with certain throttles, boosters or other equipment? If the problem happens with just one piece of equipment, then you may need to have it repaired. Check the RJ12 jacks to be sure the pins are not mis-aligned.

Does it occur only when plugged into a certain LocoNet jack? Check the wiring to that jack, particularly if you are using telco type jacks that you wired yourself. Use your LT-1 to test the LocoNet cable you are using in that area of the layout.

Have you recently changed anything in your layout wiring? If so, try disabling the change to see if they layout will run without the “upgrade.” You may need to de-bug the upgraded wiring.

Have you changed any of the DCS100 or DT300 option settings? If so, go back and re-set them to the default values and check to see if the layout will run.

Have you recently installed additional boosters on your layout? If so, check to be certain that these boosters are set up properly as boosters. If more than one command station is operating on your layout, you may experience unexpected operation when the decoders are taking commands from two different sources (command stations.)

When LocoNet is first powered up all Digitrax command stations check for other command stations also operating on LocoNet. The first command station that powers up will become the command station and all others will automatically operate as boosters. If you have two separate operating LocoNets and you connect them with a LocoNet cable, both command stations will continue to operate and operating problems will occur. Modular layouts are at a high risk of encountering this problem if more than one part of the layout is up and running and then those parts are added together. Be sure in this case that you completely power down all operating LocoNets before combining them into one big LocoNet to avoid having more than one command station trying to run the layout.

5.0 DCS100 Control Panel

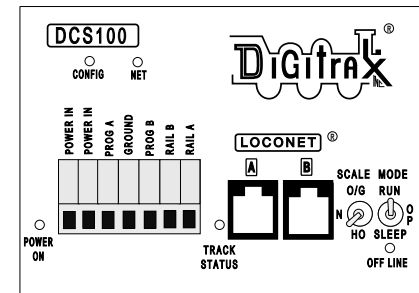

5.1 Power Input

The two “POWER IN” terminals on all Digitrax boosters & command stations are the power input connections. Digitrax does not recommend sharing a common power source between multiple Digitrax products. Each unit should have its own dedicated power supply for best system performance.

5.1.1 Transformer

Digitrax recommends the PS515 power supply to power all DCS100s. There are many other transformers and power packs that can supply the input power for the DCS100. Check with your Digitrax dealer for suggestions. Most regular DC model railroad power packs are not able to supply 5 amps to the DCS100 booster, because they were designed to run only 1 or 2 locomotives in a DC blocked system. With DCC you’ll be running multiple locomotives in the same power district so, you’ll need to provide more power to each district.

Table I: DCS100 Transformer Requirements

AC or DC	AC 50/60Hz	DC
Max Input	20V RMS AC	28V DC
Min Input	12V AC	12V DC
Optimal Input Current	5 Amps	5 Amps

Power to the DCS100 should not be rapidly cycled ON-OFF-ON. When power to the unit is switched off, wait 30 seconds before turning on the power again.

5.1.2 Heat Dissipation

It is normal for the DCS100 to be warm to the touch when it is in use. It is designed to absorb and dissipate the power difference between the input voltage and the selected scale output stabilized voltage, at the current load being drawn. If the unit is not able to dissipate excess heat, over temperature thermal shutdown may occur. We recommend that you locate the boosters in a location where they can dissipate heat. If you experience frequent over temperature shutdowns, add a small fan to help cool the booster.

5.2 Power On Indicator

This green led indicates that the power to the DCS100 is on.

5.3 Ground Terminal

The terminal marked ground provides electrical safety features and an RF ground reference for minimum radiated noise. This should be the ONLY point of any DCS100 installation that is connected to the AC safety ground pin provided on most 3 pin 110V AC power sockets. Grounding the system is a sensible safety precaution that should not be ignored.

5.4 RAIL A & RAIL B Terminals

Connect these terminals to the track on all Digitrax boosters and command stations. If you are using more than one booster, always connect the same rail to the same terminal on each booster, for example connect all Rail A terminals to the right rail and all Rail B terminals to the left rail or vice versa on all track sections.

5.5 TRACK STATUS Indicator

The “TRACK STATUS” “ indicator shows that there is voltage on RAIL A & RAIL B terminals. The color indicates the type of signal. If it is orange the track is getting DCC signals with no analog zero stretching. If the color is

green or red then a “stretched zero” signal is being used to operate a conventional locomotive. When zero stretching is present, the DCC decoder equipped locomotives will read their digital commands normally and perform as commanded. If the Track Status indicator is not lit there is no voltage on the track, the track power to the DCS100 may be OFF.

5.6 OFF LINE Indicator

The DCS100 automatically shuts down when the heat sink temperature rises to around 45 to 50 degrees Celsius and the “OFF LINE” indicator will glow red. The DCS100 automatically resumes operation when the heat sink cools down to approximately 40 degrees Celsius.

The “OFF LINE” indicator will also be lit when there is no track status. This is normal and you should not be alarmed.

Troubleshooting DCS100 Shutdowns

If the DCS100 unit shuts down frequently:

1. Move the DCS100 so that the heat sink has a flow of cool air.
2. Place the DCS100 out of direct radiant heat like sunshine or a room heater.
3. Try direct cooling by using a small fan to blow air onto the heat sink.
4. Lower the track load current.
5. Reduce the input voltage from the transformer.

If the DCS100 beeps 4 times and shuts down briefly and then comes back on again, it is probably being run too close to its pre-set current limit. In this case it may clip or mutilate some outgoing packets to keep the track current within acceptable limits. To solve this problem, reduce the track current load by setting up additional power districts to provide more total power for the layout.

5.7 PROG A & B

The “PROG A” and “PROG B” terminals are the output for the second set of DCC signals which allow you to set up a programming track that can be used while the rest of the layout continues to run.

Prog A & B can also be used to set up braking sections on your layout. This is useful if you want to stop trains at given points on the railroad, for example at a station. Instructions for setting up brake sections can be found on our web site www.digitrax.com in the “Application Notes and Technical Information” section.

5.8 LocoNet Ports A & B

These ports let you expand your Digitrax system by simply plugging LocoNet devices in to the system.

5.9 MODE Switch

The 3 MODE switch settings are:

RUN is for normal operations. 

OP is used to customize the DCS100 by changing its option switch set-

tings. 

SLEEP is used to shutdown the system and all throttles that are plugged

in to the system. 

5.10 SCALE Switch (O/G HO N)

This switch sets the maximum track voltage limit.

Scale	Max Track Voltage
N	12 volts
HO	15 volts
O/G	20 volts

5.10.1 Track Voltage Adjustment

The actual track voltage supplied by the DCS100 can be adjusted. To do this, you must open the DCS100 case (this will not void your warranty).

1. Remove the DCS100 input power & disconnect all DCS100 leads.
2. Remove the two screws on the top and bottom of each side of the case.
3. Slide the gray front panel off the DCS100.
4. Be careful to avoid disturbing components other than the ones described below.
5. Locate the small yellow trimmer potentiometer behind the LocoNet B Port and Scale Switch.
6. Use a small screwdriver to turn the potentiometer clockwise to increase the scale voltage setting. Turn it counter clockwise to decrease the voltage setting.

7. To determine the actual track voltage, measure the DC voltage (unloaded) from either the RAIL A or B Terminal to the green ground wire on the case. Multiply the measured voltage by 2 to determine the approximate digital track voltage supplied.

5.11 DCS100 Audible Sounds

The DCS100 uses several beeps and clicks that can be used as diagnostic tools that help you debug a number of conditions.

Table II: DCS100 AUDIBLE SOUNDS

Sound	Meaning
1 Beep	DCS100 has powered on successfully or has sent a programming command.
3 Beeps	A loco address has been "purged" due to non -use. This is informational only. Refer to the DCS100 Option Set Up Section for information on customizing loco address purging.
4 Beeps	Booster short circuit shutdown. Fault Alarm
6 Beeps	Command station already present in system. When two command stations are operating on the same system, you may experience unexpected results.
7 Beeps	DCS100 CMOS battery low condition. Battery should be replaced as soon as possible. See Section 5.14 for CMOS battery replacement instructions.
8 Beeps	Memory ECC/checksum fail. This indicates that the local CMOS memory has been corrupted and was reset automatically. This is a technical diagnostic.
9 Beeps	DCS100 transmit failure, there is a device blocking proper message action on LocoNet.
16 Beeps	Software timeout failure. No action is required, the unit will resume operation.
Continuous Soft clicks	Low input power supply voltage. If the DCS100 input voltage falls below about 9.5V DC or 8V AC while operating, the DCS100 will emit a series of continuous soft clicks until the low voltage condition is corrected.

5.12 NET Indicator

The NET indicator is a red led that displays information about what the DCS100 sees on LocoNet. When your layout is wired correctly and LocoNet is operating properly, the NET indicator will be on and it will flicker off any time a good LocoNet message is detected by the DCS100. The table below explains the patterns you will see for this indicator.

NET Led Indication	Meaning
Solid Red	LocoNet OK
On, blink off	DCS100 detects a valid LocoNet message
Off	DCS100 detects a short circuit on LocoNet
Off, blink every ½ second	DCS100 is in Option Set Up Mode

5.13 CONFIG Indicator

The green CONFIG Indicator shows the primary operating mode of the DCS100. This indicator should be steady green blinking off briefly once every 4 seconds. This indicates that the setting for DCS100 Option Switch 05 is set up correctly. If you see 8 blinks every 4 seconds then we recommend that you change the DCS100 Option Switch 05 to “closed.” The DCS100 will operate correctly in either case.

The CONFIG Indicator will be mainly off when DCS100 option switch 01 is incorrectly set to “closed.” In this case you must change option switch 01 to “thrown” for correct operation. See Section 26.0.

5.14 DCS100 CMOS Battery Replacement

When you hear 7 beeps when power is applied to your DCS100, you need to replace the CMOS battery. The DCS100 will continue to operate, even if this battery is not present, but all your memory settings and option switch settings will not be remembered when the DCS100 is powered down.

To replace the CMOS battery without losing any memory settings:

1. Remove the DCS100 input power & disconnect all DCS100 leads.
2. Open the DCS100 case:
 - a. Remove the two screws on the top and bottom of each side of the case.

b. Slide the gray front panel off the DCS100.

3. Locate the empty coin cell holder on the upper PC board at the top left of the unit. There are 2 battery holders and it does not matter which holder has a good battery installed.
4. Slide a new CR2032 style 20mm diameter 3V lithium coin cell in the empty holder with the “+” terminal visible on the top side.
5. Remove the old battery from the other battery holder and discard the battery.
6. Be sure not to short the arm on the top of the battery holder to the metal case or to any PC board connection inside the case.
7. Reassemble the DCS100 case. Be sure not to disturb other components and not to leave any loose parts inside when you put the case back together.
8. Reconnect the DCS100 and listen for the single beep when it comes on. If you hear 7 beeps again, either the battery was not installed correctly or it was not a good battery.

6.0 DT300 Series Throttle Control Panel

6.1 General Information

The DT300 and DT300R are full function hand held throttles that include 2 independent throttles and a common keypad to control, up to 9 functions (0-8), turnouts and programming. The DT300 does not require a battery in normal walkaround operation. If you do not install a battery, the throttle display will be off while you are unplugged from the system. The DT300 requires a 9 volt battery for infrared operation. The DT300R requires a 9 volt battery for radio operation.

Diagram 3: DT300 Throttle Controls

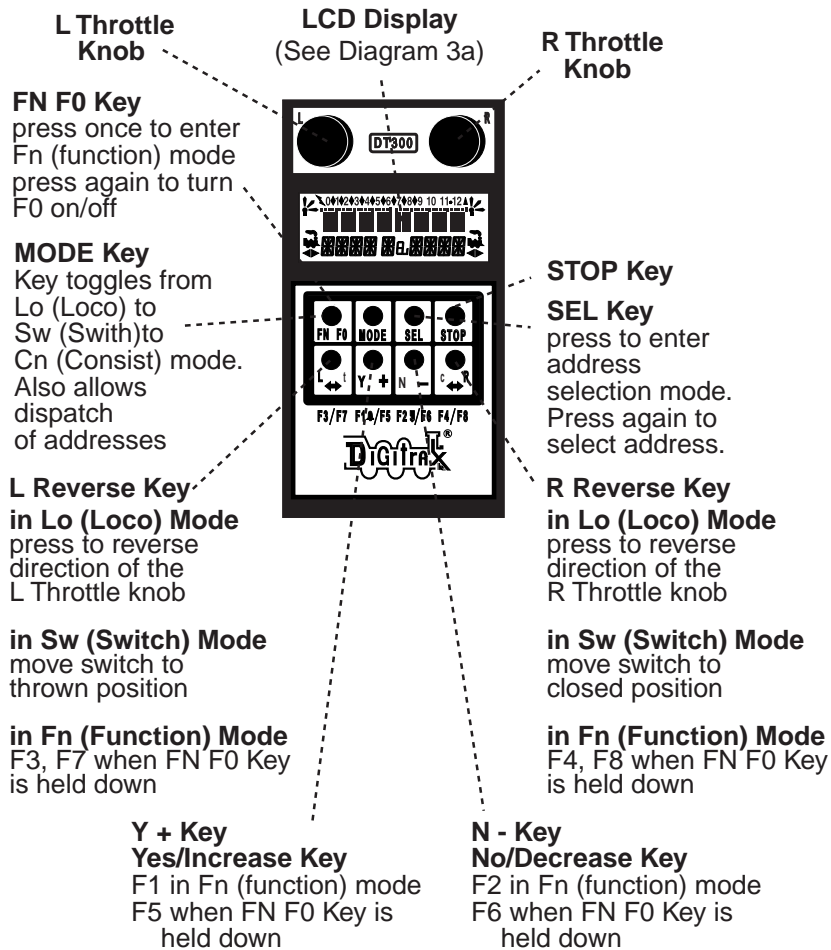

Diagram 6: DT300 Throttle Controls

6.2 L (Left) & R (Right) Throttle Knobs

Throughout this manual we refer to the throttle knob on the left side as the L Throttle and the throttle knob on the right side as the R Throttle. this corresponds to the L & R that appears on the throttle.

The throttle knobs on the DT300 use “encoders.” They give very smooth, fine speed control. In 128 speed step mode it takes four

complete rotations of the knob to go from stop to full speed. When you select a locomotive that is already moving on either throttle knob, that throttle will continue to run the locomotive at the same speed and in the same direction in which it was traveling before being selected to the throttle.

As you turn the DT300 throttle knobs you will feel a mechanical detent (and hear a beep if your throttle is set up for beeps and clicks). Each time you move the knob, the system processes information. In some cases, the LCD display will not change each time you feel the detent. If your DT300 is set up for ballistic tracking, the speed with which you move the encoder will affect how the display changes. In the case of increasing and decreasing loco speed, this is because each detent does not equal an increase of 1% speed.

You can customize the tracking characteristics of these knobs for either **straight line (normal) tracking or ballistic tracking**. With straight line tracking each movement of the knob causes a fixed rate of change. With ballistic tracking, the faster you increase or decrease the the throttle knob, the faster the data changes in the throttle. Your DT300 was shipped with ballistic tracking as the factory default setting. To change this setting see Section 25.0.

The throttle knobs on the DT300 can also be used to access the recall stack and select a locomotive to run on a throttle or to reverse the direction of the locomotive currently selected on that throttle.

6.3 Liquid Crystal Display (LCD)

Diagram 7: DT300 LCD

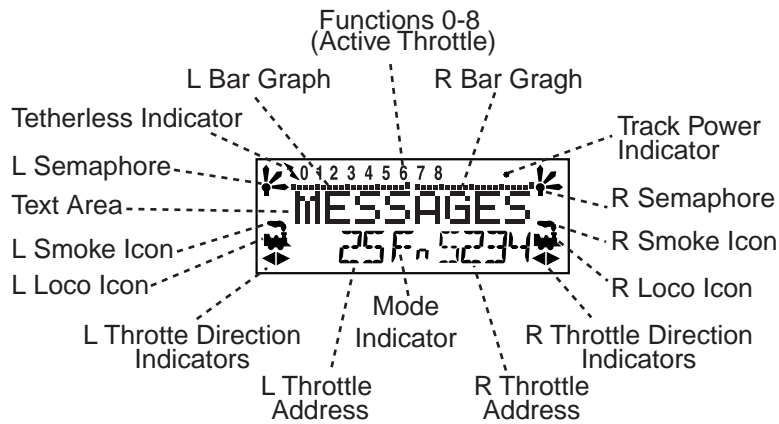

6.3.1 Loco Icon

The L & R Loco Icons  are used to indicate whether an address is available for selection. A blinking loco icon means that the address is available for selection and a steady loco icon means that the loco address is currently selected or in use by another throttle.

6.3.2 Direction Indicators

The direction indicators  are located in the LCD Display of the DT300 directly below the Loco Icon. There are separate indicators for the L (left) and R (right) throttles. If the arrow points to the front of the loco, the throttle is in the forward direction. If the arrow points to the back of the loco, then the throttle is in the reverse direction. If there is not a locomotive selected on a throttle the loco icon will not appear.

 = Forward Direction  = Reverse Direction

Note: These direction indicators are for DCC equipped locos only. They will indicate direction based on the normal direction of travel that you set up for your DCC equipped loco. If you are using an analog loco, the direction indicator may or may not match the actual direction of the analog loco.

6.3.3 Smoke Icon

The Smoke Icon is located just above the Loco Icon. Both the L & R Throttles have a smoke icon. If a loco is selected on either throttle, the Loco icon will appear beside the address of that loco. If nothing

is selected, there will be no Loco icon and the address area will show SEL. The blinking smoke icon indicates which throttle is currently active (having its function states displayed in the top line of the LCD). Since both throttles must share the keypad, only one at a time can have access to the keypad and function controls. The active throttle has access to the function controls and the status of the functions for the active throttle are displayed in the top line of the LCD. To make either throttle the active throttle simply click it once or turn the Throttle knob a little.

No Loco Icon = nothing selected on this side of the throttle

 Loco with steady smoke = Keypad and function display not active for locomotive address selected on this throttle.

 Loco with flashing smoke = Keypad and function display active for the locomotive address selected on this throttle.

6.3.4 Mode Indicator

The mode indicator, located at the bottom center of the LCD, shows the DT300's current mode of operations.

Table III: DT300 Mode Indicator Display

Display	Mode	Used For
Lo	Loco	Normal locomotive operation
Mu	MU	Multiple unit (consist) operation set up and break up
Sw	Switch	Accessory decoder control (turnouts, etc.)
SE	Status Edit	Change locomotive speed steps to 14, 28, or 128 as needed
Pg	Programming	Paged-Digitrax preferred method
Ph	Programming	Physical Register
Pd	Programming	Direct
Po	Programming	Operations Mode (Ops Mode) programming on the mainline.
RE	Recall	Recall one of the last 4, 8, or 16 locomotive addresses used
EC	Edit Clock	Edit the time shown on the fast clock
EF	Edit clock Rate	Edit the fast clock rate
EA	Edit Alarm	Edit the alarm time set for the throttle

The DT300 automatically defaults to the Loco mode & returns to this mode after about 6 seconds of inactivity in MU or Switch modes.

6.3.5 L (Left) & R (Right) Throttle Display

The decoder address selected on the L Throttle is displayed on the bottom line of the LCD to the left of the Mode Indicator. The decoder address selected on the R Throttle is displayed to the right of the Mode Indicator. The address can show as either the 2-digit or the 4-digit decoder address. If no address is selected the display will show "SEL." If a 2-digit address is selected (00-127), the display will show two or three digits. If a 4-digit address is selected (0128 - 9983), the display will show all four digits including the leading zero.

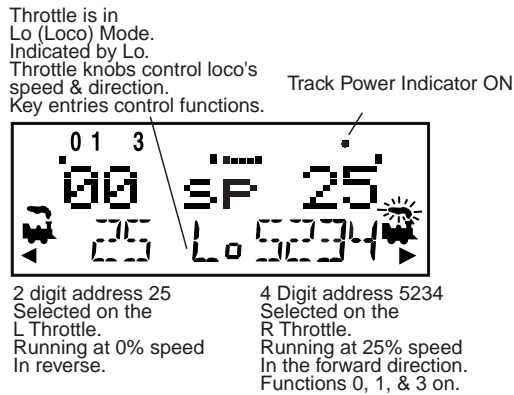

6.3.6 Text Area

The Text Area of the LCD consists of the eight characters in the middle line of the display. This is where information like locomotive speed, decoder status, turnout position, fast clock, text prompts, messages and programming data are displayed.

6.3.7 L & R Bar Graph

Each throttle has a bar graph located above the text area of the LCD. Each of these indicates the speed setting of the L & R Throttles graphically from a single dot (0% throttle) to 20 dots (full throttle). This is useful when the text area is showing information other than speed.

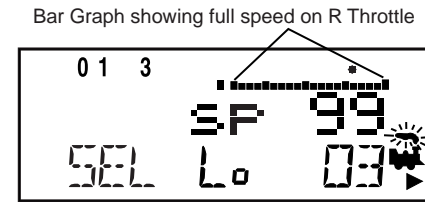
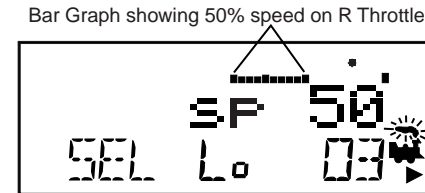
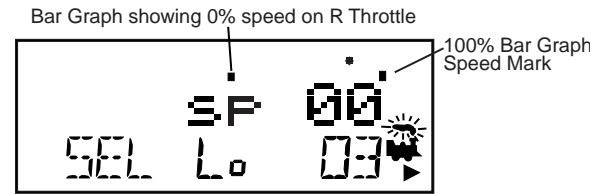

6.3.8 Function Display

Whether functions 0-8 are on or off for the currently active loco address is displayed on the top line of the LCD. The functions for the active throttle (the one with blinking smoke) are displayed. To view the function status of either throttle, simply press the throttle knob to display the active functions for that throttle.

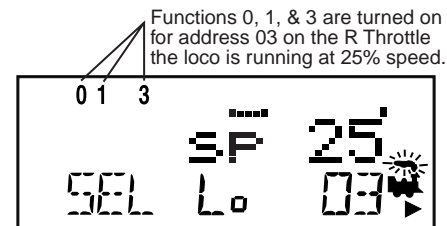

6.3.9 Track Power Indicator

This very small star shaped dot located in the top line of the LCD on the right side indicates the status of the track power.

No indicator = System track power is OFF

Indicator On Steady = System track power is ON

Blinking Indicator = System is in "STOP" and track power is ON

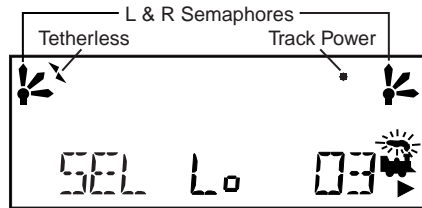

6.3.10 Tetherless Indicator

The tetherless indicator shows when your throttle is using either infrared or radio communications.

6.3.11 L & R Semaphores-Cab Signaling

The L & R Semaphores are used when cab signaling is implemented on the layout. More information about signaling and detection will be available on our web site, www.digitrax.com as these products become available. Information on how to activate these indicators will be included in the manuals for our detection and signaling products. Information will also be available from other LocoNet Certified manufacturers when they have implemented these features in their software.

The L & R Semaphores will display the following:

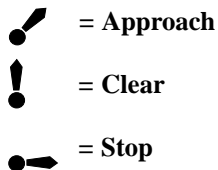

6.4 STOP Key

You can set up the STOP key to operate in one of two ways: global emergency stop or local emergency stop. You do this during throttle option set up when you initially power up each throttle. Each individual DT300 throttle on your system can be set up either way.

The STOP Key is also used as a shift key in conjunction with other keys as

described in other sections of this manual for turning layout power on and off and for entering and exiting programming mode.

6.5 SEL Key

The SEL Key , sometimes called the Select Key or Select/Set Key, is used for selecting loco addresses on to the throttles so that the address is controlled by the throttle. Sometimes people call this "assigning locos to throttles."

This key is also used to select or complete an operation.

6.6 MODE Key

The MODE Key  is used to move from one operational mode to another on the DT300 throttle and to dispatch selected addresses or consists to make them available for use by other throttles in the system.



Loco mode is the DT300's default mode since most of the time you are running locomotives. Press the MODE Key  to toggle from Lo (Loco mode) to Sw (Switch mode) to Mu (MU mode) and back to Lo, and so on.

6.7 FN F0 Key

The FN F0 Key  is used to enter function control mode and turn on and off function 0 (F0) which is usually set up to control the headlight and rear light on the locomotive. FN is shorthand for function and F0 is shorthand for function 0 or the head light function.

In Edit & Programming modes the FN F0 Key is also used to cycle among several choices.

6.8 L & R Reverse Keys

The L & R Reverse Keys change the direction of travel of the loco on the related throttle when the throttle is in Lo (Loco) Mode. The R Reverse Key  changes direction of the address on the "R" or Right Throttle. The L Reverse Key  changes direction of the address on the "L" or Left Throttle.



These keys are also used to send thrown or closed commands when the throttle is in Sw (Switch) Mode.

In the case of turnout control:

 t=thrown, turnout is set for the diverging route through the curved leg.

 c=closed, turnout is set for the main line with routing through the straight leg of the turnout.

6.9 Y + & N - Keys

The Y +  and N -  Keys are used:

- to browse addresses & increase or decrease speed.
- to link and unlink locos during MU'ing.
- to accomplish tasks using system editors.

These keys can be set up to act in two different ways:

Repeating (also called typematic) so that if you hold a key down it will continue to increase or decrease step by step until you release the key. This option is active when your throttle is set up for ballistic tracking. Your DT300 was shipped from the factory with this feature enabled.

Single Press so that you will must press the key each time you want to increase or decrease. This option is active when your throttle is set up for straight line tracking.

See Section 25.0 information on changing this setting on your DT300.

6.10 Infrared Emitters

Your DT300 has two infrared LEDs in the cable end of the throttle. These emitters send infrared signals that can be used by LocoNet compatible Infrared receivers to give you tetherless operation. See Section 23.0 for infrared operation information.

See Section 25.0 for information about customizing your DT300.

7.0 Track Power On/Off

7.1 Track Power On

When track power is on

- DT300's Track Power Indicator is on (small dot in the top line on the right side of the LCD)
- DCS100 TRACK STATUS indicator is lit and
- DCS100 OFF LINE indicator is off.

To turn track power on: Press and hold the STOP Key  then press the

Y+ Key  while continuing to hold the STOP Key. Release both keys when the system beeps and the Track Status Indicator on the DCS100 illuminates.

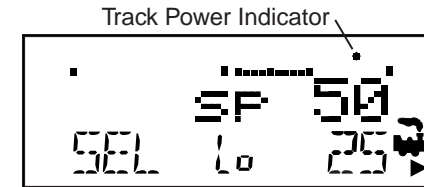

This display shows a DT300 with.

1. Track power is currently on-indicator illuminated.
2. The L throttle does not have a loco selected-SEL in lower L side of display.
3. The R throttle is running address 25 in the forward direction at 50% speed-25, train, smoke & direction arrow in lower R side of display.
4. Press and hold the STOP Key followed by the N- key to turn track power off and you will see the Track Power Indicator go off.

7.2 Track Power Off

When track power is off:

- DT300 Track Power Indicator is off (track power indicator is a small dot in the top line on the right side of the LCD)
- DCS100 TRACK STATUS indicator is off and
- DCS100 OFF LINE indicator is on.

To turn track power off: Press and hold the STOP Key  key then press

the N - Key  while continuing to hold the STOP Key. Release both keys when the system beeps and the Track Status Indicator on the DCS100 goes out.

8.0 Lo (Loco) Mode-How To Select and Run Trains

Loco or "Lo" mode is the default mode for the DT300 because it is the mode that runs your trains. If you change to Switch "Sw" or MU "Mu" mode & there is no activity on the throttle, the DT300 will automatically return to Loco mode after a few seconds.

If a throttle has a locomotive address selected, the associated loco icon and direction indicator will be lit. In addition, if the smoke above the locomotive icon is flashing, this indicates that this is the currently active throttle meaning that the Function keys on the throttle and the Function Indicators in the display are associated with that address.

To make the other throttle active, simply turn or click the other throttle knob. The smoke will start blinking on the other throttle and the function information will be displayed for that loco address.

8.1 The SEL Message

If a throttle knob does not have a locomotive selected when you make it active by turning or pressing the L or R Throttle knob or Reverse Key, flashing “SEL” will appear in place of the locomotive address in the LCD display. This is a prompt for you to select a locomotive on that throttle.

8.2 DCC Address Ranges & Display

With the DCS100 command station there are three address ranges available for addressing and programming locomotives. You can use all three address ranges at any time and in any combination you choose.

Address 00: The analog address used to run locomotives without decoders. All analog locos on the layout will respond to the speed and direction commands issued to address 00.

2 digit addressing: Addresses in the range of 01 through 127. Also called short addressing. 2 digit addressing can be used with any DCC decoder.



4 digit addressing: Addresses in the range of 0128 to 9983. Also called Extended Packet Format or long addressing. Four digit addressing can be used with any DCC Extended Packet Format, or EPF, decoder that supports this four digit addressing. The decoder must also be set up to enable 4 digit addressing.

The DT300 does not support aliasing of 2 digit addresses.

When the DT300's LCD displays a 2 digit (00 - 127) address, only the 2 or 3 digits of the address will appear in the display. When the LCD displays a 4 digit address (0128-9983), all four digits including any leading 0s will be displayed. Example: 127 is a 2 digit address and the display will read 127. 0128 is a four digit address and the display will read 0128.

8.3 Selecting An Address On A Throttle

1. Choose which Throttle (L or R) you want to use to run a locomotive. Make it the active throttle by turning it a 1/4 turn in either direction or by pressing down on the knob. If there is an address selected to the throttle, the smoke icon will be blinking.
2. Press the  Select key. The active throttle display will begin flashing the Loco Icon, the last loco address selected on the throttle and

- the Lo mode indicator. Sel Loco will be displayed in the Text Area.
3. To select a 4 digit address, use the L Throttle knob to dial up the first two digits (1000s & 100s) of the address you want to select and use the R throttle knob to dial up the last two digits (10s & 1s) of the address you want to select. Alternately, you can use just the R Throttle knob to browse from address 00(analog) to 01-127(2 digit addresses) to 0128-9983(4 digit addresses).
4. To select a 2 digit address, turn the L throttle knob counterclockwise until you see 00 appear in the display, then use the R throttle knob to dial up a 2 digit address between 00 & 127.
5. As you browse through addresses, the LCD will display current information for each address including current speed on the bar graph, current status in the Text Area, active functions on the top line of the LCD. The Loco icon will blink if the loco address is selectable and will be steady if the loco selected on another throttle. If the Loco Icon is steady, see section 8.5 for information on “stealing.”
6. Once the address you want to select is displayed, press the select key  once again to select this address on the active throttle. The LCD screen will show the locomotive's address, speed information & functions on/off for the loco you just selected.
7. The loco icon will appear in the display with a direction arrow and  blinking smoke.  The blinking smoke indicates which side of the throttle is active (is displaying function information on the top line of the LCD).
8. Use the active throttle knob to run the DCC equipped locomotive on the address you selected. As the % speed value displayed in the left side of the LCD increases, the locomotive on the track will begin to move. Press the Reverse Key associated with the active throttle to reverse the direction of the locomotive. Note: Double clicking the active throttle knob will have the same effect as the Reverse Key.

8.4 Recall a Loco

Your DT300 stores the last 4, 8, or 16 unique loco addresses used by the throttle in a recall stack. Your DT300 defaults to a 4 address recall stack. See Section 25.0 for information on how to set the recall stack depth.

For example if you have your DT300 set up for an 8 deep recall stack and the last 8 addresses you selected were: 00, 1987, 52, 0678, 03, 8819, 25, and 2500, these addresses will be in the recall stack. If you have selected any of these addresses more than once, it will not be stored twice, only the addresses not already stored will be added to the stack. The recall stack is not stored in

numeric order. This makes it convenient to select locos that you have used previously without having to dial up the address.

To Recall the last 4, 8, or 16 addresses on the R Throttle



1. Press and hold the R Throttle knob. The word “Recall” will appear in the text line.
2. When “Recall” appears in the display, release the knob. “RE” will appear in the mode indicator in the center of the bottom line on the LCD. The right side address display will begin to flash prompting you to select a locomotive. If you hold the button more than 6 seconds or if you don’t do anything for 6 seconds, the throttle will time out and return to Lo (Loco) mode.
3. Turn the R throttle knob to browse through the last 4, 8, or 16 addresses selected in the system. Whether you browse 4, 8 or 16 addresses depends on how you set up your throttle’s options. As you browse through the addresses, the throttle will display their current speed on the bar graph and their status in the text line of the LCD. Addresses are displayed in the order they were used by the throttle (not in numeric order).
4. Press and release the R Throttle knob or the SEL Key  to select the desired loco address. Once the locomotive is selected the R Throttle knob will be able to control the speed control and direction of that locomotive.

Follow the same procedure to Recall a locomotive on the L Throttle.

8.5 Stealing: Forcing An Address Selection

If you try to select a loco address that is already selected on another throttle the DT300 will display “Steal?=Y” in the text area. This is a safety interlock to prevent operators from taking control of locos that are already selected on other throttles. Occasionally it is necessary to override this interlock to gain control of a loco that is “lost” for whatever reason. This override is called stealing & can result in having a single loco address selected on two different throttles at the same time.

To steal an address with the DT300:

1. Press the SEL Key  to enter selection mode.
2. Dial up the address of the loco you want to steal and press the SEL Key  again.
3. The DT300 will display “Steal?=Y” in the text area if the loco can be stolen.

4. Press Y + Key  if you want to steal.

5. Press N -  (or any other key) if you do not want to steal.

Once a throttle has “stolen” a loco address, the slot following mode becomes active and both throttles will update speed and direction information for the loco address. This can result in strange locomotive behavior especially if one throttle is trying to stop the loco and the other is trying to speed it up at the same time.

When you have gained control of the stolen loco and are finished running it, release it from your throttle by setting the loco’s speed to 0 and pressing the SEL Key followed by the MODE Key. See Section 14.0 for more information about releasing an address.

8.5.1 Slot Following

When a DT300 detects that a loco address that is in-use on one of its throttles is being changed by another throttle or computer, it will cause the DT300 to “click” every time it sees a remote throttle change its locomotive settings. If that locomotive is in the active throttle, its speed display will also show the changes. This is called slot following. This allows two DT throttles to run a single locomotive address with both throttles being able to send commands to the loco. Both throttles will show the current speed and direction of the locomotive in their displays.

Slot following is useful for training new operators. The supervisor can “steal” a locomotive that is selected on a trainee’s throttle & be able to “look over the trainee’s shoulder” and closely supervise that locomotive’s control. The supervisor can gain instant override control without having to physically “grab” the trainee’s throttle. This lets you have unskilled visitors participating and enjoying operations without too much anxiety for either party.

Slot following also allows a computer on LocoNet to run CTC & routing control programs with automated control over locomotives. The computer can control speed and stop engines automatically while letting the engineer with the throttle in his hand know what is happening.



8.6 “slot=max” Message

If the text area of the DT300 shows the message slot=max during the selection process this means that the DCS100 has reached its limit of 22 or 120 locomotive addresses that it can manage at one time. If you want to select additional addresses, you will need to release one or more loco addresses to continue the selection process. If your DCS100 is set up for 22 slots, you can also change DCS100 option switch 44 to closed. See Section 26.0 for complete instructions for changing DCS100 option switches.

See Section 16.0 for information on how the DCS100 manages multiple loco addresses in the system at one time.

9.0 Locomotive Speed Control

To control the speed of a locomotive:

1. Select the loco address on either throttle
2. Turn the throttle knob clockwise to increase speed and counterclockwise to decrease speed or
3. Use the Y +  & N-  Keys to increase and decrease speed.

The % of full speed will be displayed in the text line of the display on the L or R side depending on which throttle is controlling the loco. The % of full speed will also be displayed on the bar graph above the text area in the display.

If a loco address is part of a consist and is not the “TOP” (or controlling locomotive) and you try to change its speed the LCD screen will show “cn” in the text area where % speed would normally appear. The “cn” lets you know that the loco you have selected is part of a consist and that you cannot change the speed or direction of this loco independently of the consist.

10.0 Stop

10.1 Setting A Loco to Zero Speed

Turn the Throttle Knob that the loco address is selected on counterclockwise until the speed display shows 00 and the loco stops moving. This lets you slow down your loco and stop it prototypically.

If you have set up deceleration for the loco and you move the throttle knob to 0% speed, your loco will slow down and come to a stop at the programmed deceleration CV value. We strongly recommend that you run your locos with the factory default of no deceleration until you are familiar with your system.





If the deceleration CV value you set for a particular loco is very large, this can make it look like the loco is not stopping on command because the deceleration CV value is causing the loco to take a long time to come to a stop.

10.2 Emergency Stop

DT300s have three ways of causing an emergency stop. Each DT300 can be set up for either local or global emergency stop during DT300 option set up. DT300s are shipped with local stop as their default setting. The third method of doing emergency stop is available on all DT300s.

1. Local STOP: Press and hold the STOP Key  for about 1 second

to stop both of the addresses selected on your L & R Throttles. To resume operation, use the throttle knobs to increase the loco’s speed.

2. Global STOP: Stops the entire layout when any operator on the system presses and hold the STOP Key  for about 1 second. To resume operation, each operator must use their throttle to set their loco’s speeds back to the desired speed.
3. Pressing the STOP Key  & the Y + Key  while the track power is on will cause the system to go into emergency stop. All locomotives will stop immediately but, track power will stay on. The DT300’s Track Power Indicator will blink. Press  &  again and the locomotives will start running again at the same speed they were running prior to STOP mode.

10.3 Turn Off Track Power



Press the STOP Key and the N - Key to turn off track power. This will stop everything on the layout. Press STOP Key and Y + Key to turn track power back on. All locos will resume running as they were before track power was turned off.

11.0 Locomotive Direction Control

Double click to reverse the direction of a locomotive running on a throttle:

1. Double click the Throttle knob that is controlling the locomotive. Press down on the knob quickly two times (2 key presses within 1/2 second).
2. The locomotive selected on that throttle will change direction.
3. Repeat the process to reverse again, etc.
4. Double clicking the R Throttle knob will reverse only the locomotive running on that throttle. Double click the L Throttle knob to reverse in the same way.

Use the L or R Reverse Keys to reverse direction:

Press the L  & R  Reverse Keys to reverse the direction of the locos selected on the respective throttles.

The R Direction Indicator under the R Loco Icon  in the LCD will indicate the direction of the loco.

If you change direction while a loco is moving it will slow down to 0 speed

and then speed up to the commanded speed according to the decoder's programmed CV values for deceleration and acceleration.

You can set up (program) each decoder with acceleration and deceleration rates that simulate the scale effects of braking the train. Then when you command an instant reverse, the system will simulate braking by slowing down the locomotive at the programmed deceleration rate, come to a stop & then accelerate at the programmed acceleration rate in the opposite direction.

12.0 Controlling Functions

12.1 Controlling F0-F8

To enter Fn (function) mode:

1. Determine which throttle you want to control functions on and make it the active throttle by pressing down on the throttle knob or by turning the throttle knob a couple of clicks.
2. Press the FN F0 Key  once to enter the function mode for the active throttle. The Mode Indicator in the center of the lower line on the LCD will show Fn (function mode).

To control functions F0-F8 in function mode:

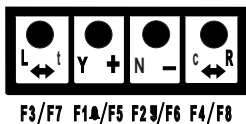

The DT300's bottom row of keys is used to control functions 1-8.

When Function Mode is active, these keys take on the meanings printed below the keys.

12.1.1 Function 0 (F0)

Press the FN F0 Key  again to toggle F0 between on and off.

Each time the FN F0 Key  is pressed while in function mode, F0 will change from off to on or vice-versa. The top line of the LCD will display a 0 when the F0 is on and will be blank when F0 is off. F0 is most often used for reversing head lights but can be set up for other functions, too.

12.1.2 Function 1, 3, & 4 (F1, F3, F4)

Press the key in the bottom row that corresponds to the function you want to toggle on or off.

F1 is labeled with a bell symbol to remind you that this is the preferred function for bell operation.

12.1.3 Function 2 (F2)

Press the key in the bottom row of the DT300 that corresponds to F2. F2 is labeled with a whistle to remind you that this is the preferred function for whistle operation. F2 is a special non-latching function. This means that if F2 is used to control a whistle or horn sound from the decoder, it will only sound when F2 is being held down. This lets you vary the length of time that the whistle blows, just like the prototype.

To latch F2 on:

1. When in Fn mode press and hold the N- Key above F2/F6
2. While holding the F2 key down, return to Lo mode by doing one of the following:
 - a. Press the MODE Key 
 - b. Press down on the either throttle knob or
 - c. Turn either throttle knob
3. Release the F2 Key after returning to Lo Mode.

Function 2 is latched on for address 03 running on the R Throttle, the loco is running at 25% speed. Note: When F2 is latched on, the speed bar graph shows 100% to remind you that F2 is latched. The loco's speed is displayed in the text area. Throttle is in Fn (function) mode and ready for the next function input.

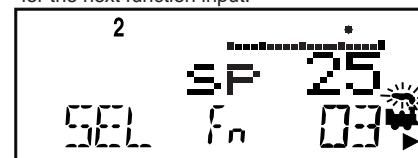

12.1.4 Functions 5 through 8 (F5, F6, F7, F8)

To access functions F5 through F8, press and hold the FN F0 Key  while pressing the keys corresponding to F5, F6, F7 or F8 to toggle between on and off for the function you choose.

Once you are in function mode you can change as many functions as you want to before returning to LOCO mode.



12.2 Exit Function Mode

To exit Fn (Function mode) and return to Lo (Loco mode):

1. If there is no function activity for about 6 seconds, the Mode Indicator will return to Lo (Loco mode) for running trains.
2. To exit function mode immediately
 - a. Press the MODE Key  twice to change to Mu Mode then to Lo Mode
 - b. Press down on the either throttle knob or
 - c. Turn either throttle knob

12.3 Controlling Functions On Consisted Locomotives

Even though an individual locomotive is part of a consist and you can't control its speed and direction separately from the consist, you can still control its function outputs independently as follows:

1. Press the SEL Key  and use the throttle knobs to browse to the address of a locomotive that is a part of consist.
2. Press the SEL Key  again to select the loco address on the throttle.
3. Use the steps described above to turn on or off the functions on the consisted loco.
4. Exit Fn (function) mode when you are finished. It is probably a good idea to release the consisted loco from your throttle in preparation for running another loco address.

13.0 Multiple Unit Operations

The DCS100 command station offers three methods of consist control:

1. The **basic consist method** is to program all the locomotives in a consist to the same address and run them on one throttle. In this case all the locomotives must be headed in the same direction, head to tail, head to tail, head to tail. If you use decoders that allow you to set the normal direction of travel of each loco, you can program locos in a basic consist to run head to head and/or tail to tail. You probably won't use this method very often in your operations because of its limitations. The basic method is the only method available to most basic command stations. We mention it here only because it is an option.
2. The **UniVersal Consisting method** handles consist information in the command station and allows you to consist locomotives with any DCC format decoder and analog locos as well. Locomotives can be

added to and removed from the consist in any orientation, head to head or tail to tail. This method has the advantages of flexibility and the ability to use all DCC decoders in consists. UniVersal Consisting is the Digitrax preferred method of consisting.

3. The **Advanced Consisting** method handles consist information in decoders that are capable of doing advanced consisting. When you use advanced consisting, your options are somewhat limited because you can't use all DCC decoders and you can't include analog locos in your consists. If you choose to use Advanced Consisting, please see the information about status editing in Section 17.0 and visit our web site for complete information about this method of consisting.

You can add a locomotive to a consist in either orientation and in any physical location in the train. When you send commands to the consist you use a single address and the command station handles the rest of the commands to the other locomotives in the consist. Since the address you will use to control the consist is not necessarily the address of the lead or head end loco, Digitrax has chosen the term "TOP" locomotive for this special address. It usually will be the train number.

- By definition, Digitrax always adds loco addresses to the "TOP" loco address in a consist.
- The "TOP" loco is special, in that it is the address that receives the speed & direction commands for the entire consist.
- All non TOP loco addresses added to the consist are controlled commands sent to the "TOP" loco.
- The TOP locomotive does not have to be a physical loco on the track, it can be a phantom.
- Digitrax defines the TOP loco as the loco on the R Throttle Knob at the time when the MU add is performed.
- All loco addresses in a consist will have the same status as the TOP loco. They will all be common, in-use or idle based on the state of the TOP loco.
- Each loco within a consist maintains its original advanced 28/128 or standard 14 speed step mode setting.
- A consist can be released by one throttle and then selected and run by any other throttle.
- A consist TOP address can be dispatched and acquired on another throttle just like any other address. See Section 14.0.



13.1 Adding a Locomotive To A Consist

Radio and Infrared throttles must be plugged in to LocoNet to add loco addresses to consists.

To set up a consist using your DT300 throttle:

1. Select the loco address of the TOP loco on the R Throttle Knob.
2. Select the address of the loco you want to consist to the TOP loco on the L Throttle Knob.
3. Move the two locomotives into position. The locomotives can be headed in either direction. They can be adjacent to each other in the train or one unit can be the mid train helper or a pusher on the end of the train.
4. Before consisting the locos, make sure that both are traveling in the **SAME PHYSICAL DIRECTION ON THE TRACK**. (The direction indicators may or may not match, the important thing is that the locomotives are set up to move in the same direction and are not pulling against each other.)
5. Press the MODE Key twice until the MU mode indicator on the LCD display is lit. The loco address in the L side of the display will blink to show that it is the address that will be consisted to the address on the R Throttle.



6. The DT300 display will prompt you to press the Y + Key  to add the loco address or the N - Key  to remove the loco address from the consist controlled by the TOP loco address selected on the R Throttle. You will see the LCD alternate between the following two screens to remind you of which key to press.

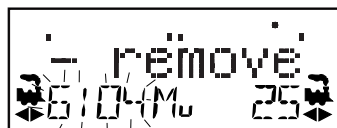
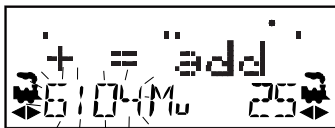

7. Press the Y + Key  to add the left address to the consist.



The L Throttle display shows the address of the loco that was added to the consist with a cn in the text line above it. The R Throttle display shows the address of the TOP loco address and its current % of full speed. The R Throttle is now in control of the speed & direction of both locomotives in the consist.



You can access the functions of the any loco in the consist by selecting the consisted loco to a throttle and using the function keystrokes outlined in Section 12.3. You will not be able to change the speed or direction of any loco that is part of a consist but, is not the TOP loco, while it is consisted.

Once a consist is set up & linked to the TOP locomotive, this TOP loco can be released & selected to run from either throttle on your DT300. The consist can also be selected and run on another throttle or it can be dispatched to another throttle.

13.2 Removing A Loco From A Consist

Radio & infrared throttles must be plugged into LocoNet to remove loco addresses from consists.

To remove a loco address from a consist:

1. Select the loco address that you want to remove from a consist on the L Throttle.
2. Press the MODE Key  twice until the Mu mode indicator on the LCD screen is lit.
3. Press the N - Key  to remove the loco address from the consist.
4. The L Throttle automatically becomes active with the loco you just removed from the consist. If you remove the loco from the consist while the consist is moving, the removed loco will be broken out of the consist at the same speed & direction that it was moving in the consist. You can uncouple and run the removed loco as an independent loco again!

13.3 Nested Consisting

The loco that was selected in the L Throttle to be added to the consist can itself be the “TOP” loco of another consist. When it is added to the current R Throttle “TOP” loco it will become a “nested” consist. In this case the whole nested consist is linked & itself will be part of the new consist.

The loco that is selected in the L Throttle to be removed from the consist can itself be the “TOP” loco of a nested consist that was linked into the current R Throttle “TOP” loco. In this case the whole nested consist is removed from the consist & returned to the L Throttle as a consist.

13.4 MU of Mismatched Locomotives



If all the locomotives in the consist have performance characteristics that are closely matched, you can run all the consisted locomotives in 128 step mode. If the units are completely mismatched (for example if you are running two different brands of locos with noticeably different characteristics), then we recommend speed matching the locos by programming Loadable Speed Tables (See your Mobile Decoder Manual more information).



14.0 Releasing An Address From A Throttle

When you are finished running a locomotive address, set the speed to 0 and release it from your throttle so that it is available for other throttles to select and run.

Radio & Infrared Throttles must be plugged in to LocoNet to release an address from your throttle. You can disable this safety feature by setting your DT300's Op#3 to one of the values that allows tetherless release (See Section 25 for instructions).

To release an address from a throttle:

1. Use the throttle to make the locomotive's speed **zero** (this step is optional but strongly recommended).
2. While the loco's address and speed information is displayed on the LCD, press the SEL Key  to go into select mode. This will release the address from your throttle immediately.
3. The address will begin to flash in the LCD display. Press the MODE Key  to dispatch the address on the throttle and the locomotive will be released to the system and marked as a dispatched address. The LCD in your DT300 will show SEL. See Dispatching below.
4. If you do not press any key within about 6 seconds, the throttle will time out normally and show SEL in the address display area.



5. If you press the SEL Key  again, the throttle will begin flashing the address you just released. You can re-select that address by pressing the SEL Key  or you can use the throttle knobs to browse to a new address and select it instead.

14.1 Dispatching addresses or consists

Dispatching is a special feature incorporated in the LocoNet “language” to meet the needs of operators that wish to enforce a strict discipline in how operators gain access locomotives during an operating session. Dispatching also lets you run consists with basic throttles that can't set up their own consists and run four digit addresses on basic throttles that only have two digit capability. It lets you have newcomers run trains on the layout without giving them access to the entire operation.

When you dispatch a locomotive address or consist to your LocoNet system, you make it available to be acquired by another throttle. Only one address at a time can be marked as a dispatched address in the system. The dispatched loco address is acquired by the first throttle to request it by pressing the ACQ key to select it for use on that throttle.

To dispatch a locomotive address using a the DT300

1. Press the SEL Key  to enter address selection, browse to the address you want to dispatch.
2. Press to the MODE Key  to dispatch it to your LocoNet system, that's all there is to it!

The dispatched address can be a single locomotive address, either two digit or four digit, or a consist that was set up by the DT300. The TOP locomotive in a consist or MU can be dispatched to transfer control of the entire consist to another throttle.

Radio and infrared throttles must be plugged in to LocoNet to dispatch loco addresses.

Acquiring a “dispatched” locomotive using a UT1 or UT2

1. Set the address selector switches to address “99” then press the “ACQ” button.
2. The Status led will light green showing that you now have control of the dispatched locomotive. (See Users Manual for UT1 or UT2 for complete instructions).

15.0 Programming and Configuration

Your DCC Decoders have many different configuration variables (CVs for short) that let you set up a different set of characteristics for each decoder installed in each locomotive.

Each of these CVs controls a characteristic of the decoder. See Table III for a list of the most commonly used CVs and their meanings. Each decoder comes pre-programmed from the factory with the default settings outlined in your decoder manual. You can change your decoder's performance characteristics by changing the CV values entered in the CVs you want to change. Each of these CVs can be set up when your command station is in the programming mode or by using the Digitrax PR-1 Computer Programmer & your PC. The CVs are remembered in the decoder until it is reprogrammed to with a different CV value. Please refer to your Digitrax Mobile Decoder Manual for a complete listing of the CVs supported by each decoder.



It is a good idea to run your decoders with the default CV values that come pre-programmed in your decoders until you get used to the system & what it can do for you. Once you are comfortable with running the trains, then you can begin customizing loco characteristics.

The DCS100 command station sends programming information to the decoders through the rails. This information is sent as a broadcast message to any decoder that is on the track when the message is sent. This means that you could reprogram all the locomotives on the layout with just a few keystrokes. (See section 4.6 Separate Programming Track)

When the DCS100 running as a command station receives a programming command from any throttle on LocoNet, it shuts down all expansion boosters connected to it and stops all locomotives. The DCS100 then sends the programming command to any decoder on the track directly connected to the DCS100 command station. The DCS100 beeps once to indicate that it has sent the programming command. Power districts connected to expansion boosters will not receive the programming commands.

15.1 Programming Decoder Addresses

Radio & infrared throttles must be plugged in to LocoNet to program CVs on the programming track. Ops Mode programming can be done without plugging radio throttles in to LocoNet. IR throttles must be plugged in for Ops Mode Programming.

1. Be sure that only the loco you want to program is on the programming track. If you are using operations mode programming, the loco you want to program can be anywhere on the layout but it must have a decoder that is capable of ops mode programming installed.
2. Press and hold the STOP Key  then press the FN F0 Key  at the same time to enter programming mode. The DT300 will display:

The LCD display shows the word "Program" on the top line and "CVNo P6 dAt" on the bottom line.

Program in the text area announces that you are in programming mode. The mode indicator in the center of the bottom line of the LCD shows which programming mode the throttle was using the last time it was in programming mode.

Pg=Paged mode (Digitrax Preferred Programming Mode)

Ph=Physical register mode

Pd=Direct mode

Po=Operations mode In ops mode, the left side of the display will show the address that will have programming commands directed to it. Ops mode is discussed separately in Section 15.4.

3. After a few seconds, the LCD will display the last CV and CV Value you programmed. If the display does not show Ad2=???, turn the L Throttle knob counterclockwise until you see Ad2 in the left side of the display:

The LCD display shows "Ad2=???" on the top line and "CVNo P6 dAt" on the bottom line.





4. If you want to program a 4 digit address, press the R Throttle once to change the display to:



The LCD display shows "Ad4=???" on the top line and "CVNo P6 dAt" on the bottom line.

You can toggle between 2 & 4 digit address programming by pressing down on the R Throttle Knob.

5. Use the FN F0 Key  to select which programming mode you

wish to use. Press the FN F0 Key to toggle between PG, PH, Pd, & Po. Digitrax recommends using the PG, or Paged mode for programming all Digitrax decoders when using service mode on the programming track. If you are using non-Digitrax decoders you may need to change to a different mode if they are not capable of Paged mode.





6. To program a 2 digit address, use the R Throttle knob to dial in the address and press the SEL Key  to program the decoder.
Note, then programming a 2 digit address, the decoder automatically enables 2 digit addressing.
7. To program a 4 digit address, use the DT300's Throttle Knobs to dial in the 4 digit address you want to program. Use the L Throttle to dial up 1000s & 100s and the R Throttle to dial up 10s & 1s. Press the SEL Key  to program the decoder.
8. When the SEL Key  is pressed, the throttle will beep and display Ad2=0wr or Ad4=0wr followed by a blinking square during programming. If you programmed a 2 digit address, you can proceed to step 13 to program other CVs or you can exit programming mode and run trains.
9. If you are programming a 4 digit address, there is one more step: the throttle will display Ad4on?=Y. This is prompting you to set CV29 to a value of decimal 038 or hex x26 which will enable the 4 digit address that you just programmed in 128 speed steps with analog mode conversion on.
10. Press the Y + Key  to enable the 4 digit address. If you don't do this before the throttle times out, simply press the SEL Key 

again to program the address followed by the Y + Key  to enable it.
11. The display will show the 4 digit address that you just programmed and enabled.
12. To program additional CVs you must start in 2 digit address programming so, press the R Throttle knob to return to 2 digit address programming.
13. Use the L Throttle to dial up the CV# you want to program and the R Throttle to dial up the CV value you want to enter and press the SEL Key  to program.

NOTE: You can program as many CVs and their values as you want in a

session. When you are finished, press and hold the STOP Key 

then press the FN F0 Key  at the same time to exit programming mode. The LCD will return to normal Lo (Loco) mode.

14. To exit programming mode, press the STOP Key  and the FN F0 Key . The LCD will return to normal Lo (Loco) mode.
15. Move the loco programmed back to the layout and you are ready to run. If you used ops mode programming on the layout, you will not have to move it. To select and run the loco you just programmed, press the L or R Throttle to activate it, press the SEL Key , dial up the address you want just programmed and press the SEL Key  again to select the address on the throttle.

15.2 How to Program Other Configuration Variables

15.2.1 Hex Display & Decimal Display

All CV values except for 2 digit and 4 digit addresses can be displayed as either decimal or hexadecimal numbers by the DT300. When you are using the L Throttle knob to browse through CVs 002 through 255, you will use the R Throttle knob to set the CV value you want to program. By default, the DT300 displays the CV values as decimal numbers 000-255 (nnn). To view the numbers as hexadecimal simply press the R throttle knob and you will see the CV value change to the hex equivalent of the decimal. Hex numbers are displayed as xnn. For example the decimal value of 006=the hex value x06. The decimal value 011= x0B. The ability to toggle between decimal and hex effectively gives you an instant conversion table.

15.2.2 Programming CVs Other Than Addresses

There are many different CVs that have been defined to handle many characteristics you might want to use for your locomotives. Table III below contains a list of the CVs used most often. Your decoder manual has a complete listing of CVs that are available in specific decoders, what they do and suggested values for each CV.

1. Place the decoder equipped locomotive you want to program on the programming track.
2. Enter Program Mode by holding down the STOP Key  & press-

ing the FN F0 Key  at the same time. The display will show the last CV and CV Value you programmed.



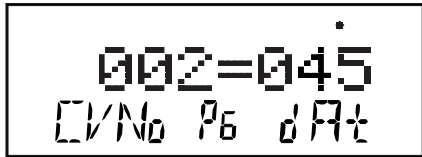

3. Select the programming mode you wish to use by pressing the FN F0 Key until the method you want appears in the Mode Indicator.
4. To program CVs other than addresses, use the L Throttle to dial up the CV# you want to program and the R Throttle to dial up the CV value you want to enter. Remember that you can use the R Throttle to display the CV value in either decimal or hexadecimal format by pressing down on the R Throttle Knob.
5. Press the SEL Key  to program the selected CV value into the selected CV.

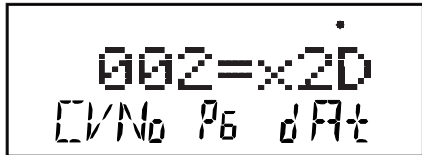

Use Paged Mode (PG) to Program CV02-Start Voltage To a CV value (dAt) of 045 (decimal)



Press the R Throttle Knob to display CV value of 045 decimal as x2D hex

6. To exit programming mode, press the STOP Key  and the FN F0 Key . The LCD will return to normal Lo (Loco) mode.
7. To select and run the loco you just programmed, press the L or R Throttle to activate it, press the SEL Key , dial up the address you want just programmed and press the SEL Key  again to select the address on the throttle.

You can program as many CVs and their values as you want in a session.



When you are finished, press and hold the STOP Key  then press the FN F0 Key  at the same time to exit programming mode. The LCD will return to normal Lo (Loco) mode.

Table III: Most Commonly Used CV's

CV	Used For	Decimal Value Display Range	Hexadecimal Value Display Range
Ad2 (01)	Loco 2 digit address	000-127	
Ad4 (17 & 18)	Loco 4 digit address	0000-9983	
02	Start voltage (Vstart)	000-255	x00-xFF
03	Acceleration rate	000-031	x00-x1F
04	Deceleration	000-031	x00-x1F
05	Max voltage (Vmax)	000-255	x00-xFF
06	Mid-point voltage (Vmid)	000-255	x00-xFF
29	Configuration register	See Table	See Table IV

15.3 CV29 Configuration Register Programming

The Configuration Register CV29 is used for setting several different decoder characteristics at one time. To determine what CV value to enter in CV29, check Table IV below or check your decoder manual for more information and other options. These are some of the common hexadecimal (hex) values used in the Configuration register (CV #29) & their meaning.

Table IV: CV29, The Configuration Register

The look up table below shows the effects of different CV values that you can program into CV29.

CV Value For CV29	Speed Steps/ Speed Table	Analog Mode Conversion	Normal Direction Of Travel	2 or 4 Digit Addressing
00	14	OFF	Forward	2
01	14	OFF	Reverse	2
02	28/128	OFF	Forward	2
03	28/128	OFF	Reverse	2
04	14	ON	Forward	2
05	14	ON	Reverse	2
06	28/128	ON	Forward	2
07	28/128	ON	Reverse	2
10	14 Speed Table	OFF	Forward	2
11	14 Speed Table	OFF	Reverse	2
12	28/128 Speed Tbl	OFF	Forward	2
13	28/128 Speed Tbl	OFF	Reverse	2
14	14 Speed Table	ON	Forward	2
15	14 Speed Table	ON	Reverse	2
16	28/128 Speed Tbl	ON	Forward	2
17	28/128 Speed Tbl	ON	Reverse	2
20	14	OFF	Forward	4
21	14	OFF	Reverse	4
22	28/128	OFF	Forward	4
23	28/128	OFF	Reverse	4
24	14	ON	Forward	4
25	14	ON	Reverse	4
26	28/128	ON	Forward	4
27	28/128	ON	Reverse	4
30	14 Speed Table	OFF	Forward	4
31	14 Speed Table	OFF	Reverse	4
32	28/128 Speed Tbl	OFF	Forward	4
33	28/128 Speed Tbl	OFF	Reverse	4
34	14 Speed Table	ON	Forward	4
35	14 Speed Table	ON	Reverse	4
36	28/128 Speed Tbl	ON	Forward	4
37	28/128 Speed Tbl	ON	Reverse	4

Note that with Digitrax Standard Decoders (non FX decoders), if 128 speed steps are sent by the command station then the 14/28 speed step & loadable speed table selections are not used.

15.4 Operations Mode Programming



Operations mode programming lets you program CVs in DCC locomotives equipped with Extended Packet Format decoders while they are on the main-line. A typical use for Ops mode programming would be to change the acceleration rate (CV03) or the deceleration rate (CV04) of your locomotives to simulate the weight and braking capability of the train to compensate for changing the number of cars or power units on a train.

Your DT300 can use ops mode programming to change the CV value in ANY CV, including 2 digit and 4 digit addresses.

Ops mode programming can be performed by any DT300 at any time since the throttles are not competing for usage of the single programming track.



Radio throttles do not need to be plugged in to LocoNet during Ops Mode Programming. When you enter programming mode with a radio throttle, Ops mode is the only programming mode that will be available unless you plug in to LocoNet. IR throttles must be plugged in for Ops Mode.

How to use Operations Mode Programming

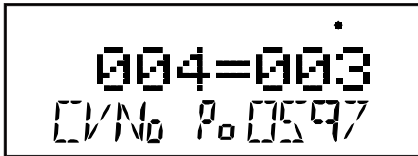
1. Select the DCC loco address that you want to program on either the L or R Throttle. Be sure that the address you want to program is the active throttle, the one with the blinking smoke when you enter programming mode.
2. Press and hold the STOP Key  & then press the FN F0 Key  at the same time. Release both keys when the program display comes on.
3. Press the FN F0 key  to scroll from "Pg" to "Ph" to "Pr" to "Po" until Po appears in the mode indicator in the middle of the bottom line of the display. If you are using an infrared or radio throttle, the display will automatically show Po. The DT300 display will display the address that was selected on the active throttle in the right side of the bottom line of the display. This is the address that you are preparing to program.
4. Use the L Throttle knob to dial up the CV you want to modify. Use the R Throttle knob to dial up the CV value you wish to program for the CV.



This display shows a typical operations mode programming screen:

1. **Po** in the Mode Indicator Area shows that we are in Operations Mode Programming
 2. **0597**, the address being programmed appears in the lower right corner. This is the address that was selected on the R Throttle when programming was initiated.
 3. **CV Number 004** (deceleration)
 4. **CV Value of 003** (a moderate amount of deceleration)
5. When the CV and the value you want to program for that CV appear in the display, press the SEL Key  to send the programming commands.
 6. To return to Lo (Loco) mode from Operations mode programming, simply press the STOP Key  & FN F0 Key  simultaneously again to return the DT300 to LOCO mode.
 7. With ops mode programming, the DCS100 does not turn off track power so, you do not need to turn it back like you did with service mode programming.

15.5 Busy or Fail Message





If you get a “Busy” message in response to any programming task, the system is temporarily busy and you will have to try the task again until you get a “Good” response.

If you get a “Fail” message in response to any programming task, check to be sure that there is a loco on the programming track and that the programming track is powered.





15.6 Reading Back CV Values Programmed

Your DCS100 and DT300 together can read back the configuration variable values programmed into your decoders. Since you must use the programming track for this, infrared and radio throttles must be plugged in to LocoNet to read back CV & their values.

To read back CV values:

1. Place the decoder equipped locomotive you want to program on the programming track. You can also do ops mode read back with Digitrax transponding decoders if you have a LocoNet device that allows ops mode read back plugged in to LocoNet.
2. Enter Program Mode by holding down the STOP Key  & pressing the FN F0 Key  at the same time. The display will show the last CV and CV Value that you programmed.
3. Select the programming mode you wish to use by pressing the FN F0 Key  until the method you want appears in the Mode Indicator. You can read back in PG, PH, Pa, or Po modes with the following restrictions:
 - PG** Paged Mode no restrictions
 - PH** Physical Register Mode can only read CV01-CV08. You should not rely on values in the display for CVs above 08 when reading back in physical register mode.
 - Pa** Direct Mode no restrictions
 - Po** Operations Mode can only be used with Digitrax decoders that are capable of transponding when there is a device attached to LocoNet that supports ops mode read back.
4. **To read back the CV value programmed for the two digit address (CV01)**, use the L Throttle knob to dial up Ad02 on the left side of the text area and then, press the MODE Key . The text area will show Ad2 =rd followed by a flashing box. When the read back is finished, the CV value (the 2 digit address) will be displayed on the right side of the text area.
5. **To read back the four digit address that is programmed into the decoder** use the L Throttle knob to dial up Ad02 on the left side of the text area, then, press the R throttle knob to change to Ad4. The text area of the display will show Ad4=???? (disregard any value that appears at this time). Press the MODE Key  and the display will change to Ad4=8rd followed by the flashing box. When the read back is finished the 4 digit address will be displayed on the right side of the text area.
6. **To read back any other CV** start at AD2=??? (Use the L Throttle knob to dial in Ad2 on the left side of the display or if you were in

four digit addressing, press the R throttle knob once). Use the L Throttle knob to dial up the CV you want to read back. Press the MODE Key . the display will show the CV number=rd followed by the flashing box. when the read back is finished, the CV value for that CV will be displayed in the Right side of the text area.

7. Once you have read back any CV, you can change its value by dialing in the CV value you want to program & pressing the SEL Key .
8. To exit programming mode, press the STOP Key  and the FN F0 Key . The LCD will return to normal Lo (Loco) mode.
9. To select and run the loco you just programmed, press the L or R Throttle to activate it, press the SEL Key , dial up the address you just programmed and press the SEL Key  again to select the address on the throttle.

16.0 How Your DCS100 Manages 22 or 120 Addresses

16.1 22 or 120 “Slots” For Addresses

The DCS100 command station can run up to 120 loco addresses and throttles at a time. Each of these addresses occupies one of 22 or 120 “slots” available in the DCS100’s memory. Your DCS100 comes from the factory set for 22 slots. You can change to 120 slots by setting DCS100 option switch 44 to “closed.” Once the slots are full, the system will display the “slot=max” message to let you know that you need to release some locos if you want to select and run others (or change OpSw 44 if you haven’t already done so). The DCS100 manages the addresses that occupy slots by assigning different statuses to each decoder depending on how it is being used in the system. This allows the DCS100 to automatically remove, or purge, addresses to make room for other locos to be selected and run.

There are two factors that determine the status of each decoder: whether or not it is selectable and whether or not the command station is refreshing it. Decoder addresses are selectable if they are not being used by any throttle in the system. When your command station is running a loco on an address, it sends commands and refreshes those commands. The 22 or 120 address limit is the number of addresses that your DCS100 can refresh at the same time. When the command station refreshes data sent to decoders, it is just repeating previously issued commands. The reason for this is to be sure that the decoders don’t forget what they are supposed to be doing. For example, if your

decoder encounters a power interruption caused by dirty track, it is momentarily out of contact with the command station and it might lose the DCC signal. By refreshing the decoder’s data, the command station makes sure everything keeps running smoothly.

Your Digitrax system classifies decoders as follows:

Decoder Status	Selectable	Refreshed
New or Idle	Y	N
In-use	N	Y
Common	Y	Y

Purging of addresses:

Purging is the process by which the DCS100 changes the status of decoders that are either not being used or are unattended to make room for other addresses to be selected and refreshed by the command station.

If a DT300 with selected in-use locomotives is unplugged from LocoNet for more than about 3 1/4 minutes, the command station will change the status of these in-use locomotives to common so that they are available for selection by other throttles in the system. When this happens you will hear three beeps from the DCS100.

When the DT300 that has been purged is plugged in again, it will attempt to log on to the system where it left off. If the addresses previously in-use on the throttle have not been selected by other throttles the wayward DT300 will automatically re-log on to the purged locomotives and their status will be changed back to in-use.

In the case of both tethered and tetherless operation with IR and Radio throttles, the throttles periodically send a message to the system to keep them logged in to the system so that their locos selected are not purged. Note: See Section 24.0 for “Tetherless Operation of the DT300”.

16.2 Address Purging Strategy

The DCS100 automatically purges in-use loco addresses that have not received an update from a throttle communicating with LocoNet after a predetermined amount of time. Purging changes the decoder status to common and this makes the address available for other throttles to select and run. This safety feature allows other throttles in the system to gain control of engines that may have been left running unattended by an operator.

By setting option switches 13, 14 & 15 in the DCS100 you can customize how your system handles purging:

1. The DCS100's default is purge time is about 3 1/4 minutes (200 seconds).
2. Purge time can be increased to 10 minutes (600 seconds) by setting the DCS100's option switch 13 to closed (OpSw 13=closed).
3. Purged locomotives can be set to stop automatically when purged by setting the DCS100's option switch 15 to closed (OpSw 15=closed).
4. Purging can be disabled completely by setting the DCS100's option switch 14 to closed (OpSw 14=closed).

See Section 26.0 for complete information about setting DCS100's option switches.

17.0 Decoder Status

The command station assigns status codes to each locomotive address in the system. Addresses are either selectable or not selectable. Decoders are not selectable if they are in-use on another throttle or if they are part of a consist. If you try to select an in-use address, you will be prompted to "Steal" the address. If you select a decoder that is part of a consist, you will be able to send function commands but you won't be able to control its speed or direction. The text line in the DT300 display will show "top", "cn" or "mid" if the address is part of a consist, otherwise it will show "stat". This display is followed by the status code for one of the following modes of operation.





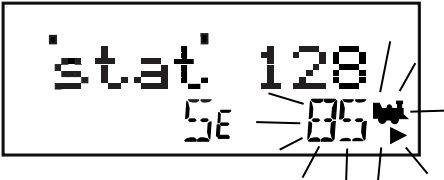



Table IV: Decoder Status Codes

Display	Meaning
28	28 Speed Step Mode
tri	Motorola Trinary Format Mode
14	14 Speed Step Mode
128	128 Speed Step Mode Digitrax Preferred Mode
*28	FX 28 speed step-enable advanced consist mode
x01	Reserved, Do not use
x02	Reserved, Do not use
*128	FX 128 speed step-enable advanced consist mode

Status editing is used most often when you are running non-Digitrax decoders that do not have 128 speed step capabilities. If you can't get a non-Digitrax decoder to work on your layout and you are sure you are using the correct address for the decoder, you probably need to status edit it to run in 14 or 28 speed step mode.

17.1 Status Editing a Decoder

To Change the Status of a Decoder:

1. Press the SEL Key  to enter address selection mode, the LCD screen will begin flashing the address on the active throttle and will display Sel Loco in the text area to prompt you to select an address. Lo will also be flashing.
2. Press the FN F0 Key  to enter status edit mode. The flashing Lo will change to SE and the current status code of the address will be displayed in the text area.
3. Use either throttle knob or the Y +  or N -  Keys to change the status code. The status code selected will be displayed in the right hand side of the display. 
4. Once you the status code you want to use for the address is displayed in the right side of the LCD text area, press the SEL Key  to change the status code of the locomotive and to select it to run.
5. If the loco address is in-use on another throttle or in a consist when you press the SEL Key  to complete the status edit process and select the loco on the active throttle, the DT300 will prompt you to Steal=Y. If you want to steal the address, press the Y + Key  to complete the status edit. If the loco is part of a consist, it will not be selected and will remain part of the consist when the status is edited.

If the throttle times out while status editing simply begin the procedure again.

17.2 Note for Non-Digitrax Decoder Users

If you have a decoder that does not have advanced 28/128 speed step mode available, you must "status edit" that locomotive to standard 14 speed step mode before running it with your Digitrax system. Changing the decoder's status will cause the system to handle this decoder as a 14 speed decoder. Status editing does not reprogram anything in the decoder.

18.0 Sw (Switch) Mode

Switch mode is used for sending commands to accessory decoders and for changing option switches in your LocoNet system. The most common use of switch mode is for operating turnouts.



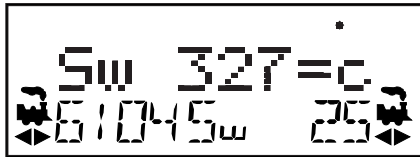

To change the position of a switch or turnout

1. Press the MODE key  until the mode indicator in the center of the bottom line of the DT300's LCD shows Sw.
2. The last switch decoder address selected by your throttle is displayed on the text line followed by a "c" or a "t".
3. The LCD indicates the switch position using the c or t as follows:
 - "t" indicates that the switch is "thrown" (for a turnout, the diverging route is set)
 - "c" indicates that the switch is "closed" (for a turnout, the mainline route is set)

If the "t" or "c" indicator is flashing it means that the LocoNet Command Station does not know the current switch position.



This display example shows Switch #327 is in the closed position.

4. Dial up the switch address you want to change by using either throttle knob or the Y +  & N -  Keys. You can also use the L throttle knob to set the 100s and the R throttle knob to set the 1s.
5. Once the desired switch address appears in the test area of the throttle, you will see either "c" or "t" on the right side of the = sign in the display. If the "c" or "t" is flashing, the command station does not know the position for this turnout. Press either the L Reverse Key  to move the switch to the "thrown" position or the R Reverse Key  to move it to the "closed" position.
6. If the switch you selected is a turnout connected to an accessory decoder, it will change position from closed to thrown or vice-versa. If the switch you selected in an op switch setting for your DCS100 command station, the software switch will be changed.
7. After commanding the switch "closed" or "thrown" the switch posi-

tion display will stop flashing, since the command station now knows the current switch position.

Note that the accessory decoders in the system are accessible to all throttles or control devices with switch control capabilities & are not reserved in-use to a single throttle like locomotive decoders.

When you have finished your Sw (switch) operations you can return to Lo (Loco) mode by:

1. Pressing the MODE Key  twice (skipping past MU mode)
2. Pressing down on either throttle knob
3. Wait for the 6 second no-input inactivity time-out to return the DT300 to the Lo (Loco) default mode.

The next time you enter Sw mode , the DT300 will remember where you left off & start at the last switch address & position you accessed.

19.0 Edit Fast Clock & Routes

Many operators use a fast clock during operating sessions to simulate prototypical operations. Traditionally, this clock is on the wall and is set up to run at a faster than normal rate. LocoNet has its own networked fast clock for all Digitrax throttles connected to your system.

19.1 Fast Clock Basics

The fast clock display is a 4 digit 12 or 24 Hour format clock. This is the display you will see when the fast clock option is set to display

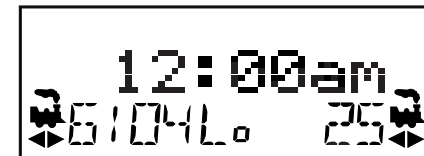

Display with FastClock showing 12:00AM

You can set up your DT300 so that its default display is either the fast clock display or the Lo mode display. When there is no activity on your DT300 for more than about 6 seconds, the DT300 will revert to the default display that you set up in the DT300. When you press any key or turn either throttle knob, the default display will change to reflect the current throttle activity. Your DT300 was shipped to you with Lo (Loco) mode as the default display showing the current speed of selected loco addresses in the text line. See Section 25.0 for information about how to change this text line to show the fast clock as your default display & how to set up 12 or 24 hour clock format.

Any DT series throttle you plug in to your LocoNet system will update its fast

clock time and rate to be synchronized to the rest of the system a couple of seconds after it is connected to LocoNet.

Each DT300 can be set up with its an alarm. When the current fast clock time matches the private alarm time set in any DT300, then that DT300 will beep and flash the message "Alarm" to indicate that the alarm time has elapsed.

The fast clock rate for the fast clock is user selectable from 1:1 to 100:1 in steps of 1. The most popular range of values is 4:1 to 8:1.

19.2 Stop the Fast Clock





Setting the clock rate to 00 will stop the fast clock for the entire system at the currently displayed time. Fast time will re-start when a new non-zero rate value is set.

The current fast clock time, fast clock rate and the DT300 alarm time can be changed by using the Edit mode.

19.3 Edit Fast Clock Time, Rate & Alarm

To Edit Fast Clock Time, Rate & Alarm

Note: DT300 must be plugged in to LocoNet to edit the fast clock settings.

1. From Lo mode, press the MODE Key  to change to Sw (Switch) mode.
2. Press the FN F0 Key  to change from Sw (Switch) mode to E (Editor) mode.
3. The mode indicator in the center of the bottom row of the display will show Ec (Edit Clock Mode) and the text area will show a 12 or 24 hour time.
4. Use the L & R Throttle knobs to dial up the "current" time. Use the L Throttle for hours and the R Throttle for minutes. You can only move time forward. Press the FN F0 Key  to set the time.
5. Once the time is set, the mode indicator will display EF (Edit Fast Rate) and the text will show Rate=nnn where nnn is the clock rate. Use the throttle knobs to dial up a clock rate that is between 000 & 255. Press the FN F0 Key  to set the fast clock rate.
6. Once the time and fast clock rate are set, the mode indicator will display EA (Edit Alarm) and the text will show a 12 or 24 hour time.

Use the throttle knobs to dial up the alarm time. Press the FN F0

Key  to set the alarm.

7. Once the time, fast clock rate and alarm are set, you will automatically return to Lo Mode (with fast clock display if you have set your DT300 throttle options for this option.

19.4 Route Basics

The DCS100 lets you set up routes that are triggered by operating a single turnout address to make it either c(closed) or t(thrown). Setting up and operating routes is similar to consisting locomotives because you can cause more than one unit to operate based on a single command sent to the system. We call the turnout address that other turnout addresses are "consisted" to the TOP address. To operate a route, use Sw (Switch) mode to select the TOP turnout address in the route and move it to either closed or thrown to initiate the route you have previously set up in your route list. The TOP turnout address does not need to be physically present on the layout, it can be a "phantom" turnout address.

The DCS100 supports up to 32 routes. Each route consists of a list that contains a TOP turnout address and its position (c or t) and up to 7 other turnout addresses and their positions. Routes are stored in the DCS100's memory and can be operated by any throttle in the system that can send switch commands. Each of these 32 routes is operated by setting the TOP turnout address to the position saved in the route list. When a route is triggered, a route can include a switch that is the Top of another route and all the entries in the second route will be added to the string of turnout commands the initial route request generates. The second route called is a "nested" route.

From the initial route you can "nest" up to 3 levels deep. Note that a route that itself does not contain another Top switch (i.e., another route) will not increase the nest depth. Knowing this, you can assemble up to 120 switch commands in a single route if you are careful when you set up your nesting.

If the DCS100 determines that you have exceeded these limits, it will beep 5 times to alert you to the problem. Note that if a route contains the same switch command more than once and this causes the route to "loop back" on itself, this will also generate a 4 beep route error indication and no switch commands will be issued to the layout. In this case you will need to edit the route and correct the errors in the list before trying the command again.

19.4.1 Enabling Routes

Before you can use routes in the DCS100 you must set the DCS100's OpSw #26 to "closed."





You can erase all current routes in the DCS100 by setting OpSw 37 to "closed."

19.4.2 DS54 Cascaded Routes

Because the DS54 can generate cascade switch message commands, it can be used to augment the DS54 "local routes" with any LocoNet route that is in the system. Even if you do not use the internal or local routes of the DS54, you can trigger up to 8 different route requests to the system from small push buttons attached to the DS54. Remember to select the correct Cascade control value from the DS54 manual so that the "thrown" or "closed" state matches that of the Top turnout address of the route you want to trigger. Also be sure to connect the DS54 to LocoNet by the black 6 pin RJ12 jack so it can "talk" to LocoNet!

19.5 Edit Routes

To go to the Edit Routes (Er) mode you must pass through the clock editor:

1. Start in Lo (Loco) mode. Press the MODE Key  to enter Sw Mode. followed by the FN F0 Key  to enter EC (Edit Clock) Mode. Press the FN F0 Key  again to enter EF (Edit Fast Rate) mode. Press the FN F0 Key  again to enter EA (Edit Alarm) mode. Press the FN F0 Key  again to enter Er (Edit Routes) mode.



This display shows Er (Edit Routes) in the Mode Indicator area on the bottom row to let you know you are in Edit Routes mode. The right side of the bottom row shows which route you are working

with. This can be any number from 01 through 32.

The left side of the bottom row of the display shows which entry within the route you are working with. The En (entry) number can be any number from 01 through 08.



En01 is the TOP or controlling turnout address. The position, c or t, that you set for this turnout address is the one that will operate the route.

The text area shows "Sw empty" to let you know that nothing has been entered for Entry 01, Route 01.

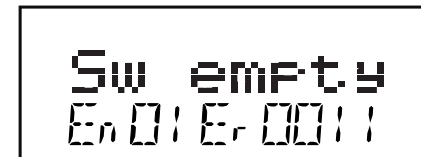
2. Use the R Throttle knob to dial up the Route number you want to work with. The bottom right display will show the route number. The DT300 will allow you to dial up above route 32 but please DO NOT USE route numbers outside the range of 01-32.
3. Use the L Throttle knob to dial up the Entry number within the chosen route that you wish to work with. The bottom left display will show the entry number.







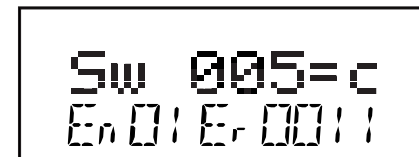

This display shows Entry 01, Route 11as empty.

4. Press either Throttle Knob or the MODE Key  and "Sw" in the text area will begin to flash, use the Throttle knobs to dial up the turnout address you want to add to the route. Use the L Throttle for 100s and the R Throttle Knob for 10s & 1s. Once you make changes to the turnout address number or the position of that address, the entire text area will begin to flash.
5. When the turnout address you want is on the screen use the L Reverse Key  to set the turnout to t (thrown) or the R Reverse Key  to set the turnout to c (closed).



This display shows Entry 01, Route 11 with turnout address 005 set for

closed. In this case address 005 is the TOP address for this route because it is Entry 01 for the Route.

6. If you wish to make no changes to the route and entry selected, simply press the MODE Key  to exit turnout address/position editing and return to selecting a different route/entry number.
7. Once your selection is complete, press the SEL Key  to save the turnout address in the position selected into the route.
8. Continue entering route entries in this manner until your route is complete. You can toggle back and forth between selecting route and entry numbers and entering turnout addresses and positions by pressing either Throttle knob or the MODE Key .
9. Once you have finished editing routes, press the FN F0 Key  to exit the Er (Edit Routes) mode and return to Lo (Loco) mode.
10. To operate the routes that you have set up, simply press the MODE Key , dial up the TOP turnout address and press the L  or R  Reverse Key to issue the appropriate t (thrown) or c (closed) command. When you select the TOP turnout address in a route and the position command (c or t) you issue matches the position that is stored in the route, the route will operate. If you select the opposite position from that stored as the route, the TOP turnout address will change to that position & the route will not operate.

Entering “empty” as a route entry

A route entry of “empty” will cause no action when a route is operated and is the normal state after clearing route memory by setting DCS100 OpSw 37 to c. You can delete any turnout address entered in a route by simply changing the route entry to “empty”. Any route entry can be set to empty in any position in a route, except for the TOP switch position. If you set route entry 01 (The TOP turnout) to empty, the entire route will not operate.

The Best Way to Set Up Routes

To use routes successfully, we strongly recommend that you set up and test a few small routes first. Once you have some small routes working the way you want them, you can combine these smaller routes into a larger, more complex

routes by including the smaller routes' TOP turnouts in one of the larger ones. This modular approach makes setting up, understanding and debugging of routes a much easier process.

DCS100 Switch Command FIFO:



The DCS100 has an incoming switch command FIFO (first in first out) buffer that can store up to 8 switch commands for action. These commands are stored in the order they were received. If you are running purely DCC switch commands the DCS100 can issue switch commands to the track as fast as the LocoNet can present throttle and computer switch requests in real time. If triary echoes are enabled then the DCS100 will “pace” or meter the switch commands delivered to the tracks to one about every 1/2 second. This allows triary switch decoders to operate correctly. This switch “metering” is in effect for both individual switch commands and routes. If you are not in pure DCC switch mode, for long routes there may be some delay from a users' switch request until the switch actually changes on the layout. This is due to the DCS100 metering out earlier requests in the Switch command FIFO.

Capacitive Discharge Solenoid Turnout Motors

If you are in pure DCC mode (OpSw 09=“thrown”) then you can force switch metering by making OpSw 31 “closed.” This can be useful when you are running Solenoid type switch ladders with “capacitive discharge” drive that needs some recovery time between operations.

20.0 Shut Down and Resume Procedures

Some users prefer to “dispatch” or release all addresses active in their system before shutting down. This can prevent unexpected results when you power up the layout again. This procedure is covered in detail in Section 14.0.

1. Turn track power off: Press and hold the STOP Key  (like a SHIFT key) then press the N - Key  while continuing to hold the STOP Key . Release both keys when the system beeps and the Track Status Indicator on the DCS100 goes out.
2. Move the DCS100's “MODE” switch to the “SLEEP” position. The DT300 throttles plugged in to the system will display “Idle” indicating that it is in “sleep” mode. On some systems, your DT300 throttle will alternate between displaying the fast clock and the “Idle” message, this is normal.
3. Turn off the power supply to the system.

The power to the DCS100 can be left on all the time if desired. In “sleep” mode, the DCS100 consumes very little energy. In this state the DCS100 provides keep alive power to all throttles that are connected to LocoNet.

21.0 Troubleshooting

21.1 Clean Track

The majority of intermittent operation problems can be traced to bad connections and poor or noisy wheel pickups on locomotives. Check track cleanliness and quality of wheel pickups. The DCC digital packet communication strategy performs exceptionally well in a less than perfect environment, and will often mask bad connections until they are really impossible to work with!

21.2 The Quarter Trick

If your track does not have adequate power supply to the locomotives, then the DCC signal won't get through either. Take a quarter or screwdriver blade and go around your layout creating electrical shorts every 10 feet. Your DCS100 should beep and shutdown when the short is present. When the short is removed, the booster should return to normal operation. If this does not happen, then you need to add more feeders.

21.3 The LT-1 Tester

Check your LocoNet cables with the LT-1 tester to be sure you don't have any cables that were made incorrectly.

21.4 Decoder Won't Respond

Is the loco on powered track? If the track power indicator on the DT300 is off or flashing, press RUN Key and the Y + Key to turn on track power. If the throttle direction indicators on the DT100/DT200 series throttle are orange press RUN Key and the Y + Key to turn on track power.

Use the “Quarter Trick” from Section 4.4 to test for track power at several locations around the layout. If there is not track power, check your layout wiring.

Can you select the loco on your throttle? If not, is the loco in use by another throttle or is it part of a consist (do you see a cn in the display when you try to select it)?

Do the settings in CV29, the configuration register, match the command station output? If your decoder is a 14 step decoder running on an Chief II, status editing will be needed.

Have you reset any CVs since the last time you ran the loco? If so, go back and change them to their default CV values and then try to run the loco. It is possible to set acceleration so high that it will take 10 minutes for the loco to start moving.

Does your throttle say “slot=max” or “FF”? This means that the system's capacity to handle operating locos is full. The Chief II can run up to 22 or 120 addresses at the same time. If you have the “slot=max” message, be sure that all locos that are not running are released from throttles or set DCS100 OpSw 44 to closed to increase the number of addresses to 120.

Was the loco running just before it stopped? If the decoder is very warm it may be in thermal shutdown. Let it cool off and see if it starts again. Also check for localized track problems.

Are there burn marks on the decoder? You'll need to send it in for repair! If all else fails, reprogram the decoder address and reset CVs to default values.

21.5 Emergency Stop

If the layout starts to “get away” on you, either PRESS the STOP Key  or, turn the track power to “SLEEP” on the DCS100. Either way will give you a chance to regain your composure, and you will be able to rejoin the contest.

21.6 Mechanical Drive Train Problems

Pay attention to the mechanical drive train and free movement of the locomotive wheel sets. This is especially important with inexpensive locomotives. Using Digitrax decoders with appropriate programming settings, you can achieve surprisingly good quality motion, if you carefully adjust the mechanisms for smooth running.

21.7 “Strange” Locomotive Lights

If you can't control the operation of the lights in your locomotive with the DT300 (in default 128, or 28 speed step mode), be sure that the decoder is programmed in advanced 28 speed step mode.

Do this by programming CV29 with a hex value of “06”. See Table IV. Refer to Section 15.3 for complete programming instructions.

Your Digitrax decoder was shipped programmed to 128 speed step mode. You may have changed your decoder's programming when performing the decoder test procedure. In any case, if you are not able to turn the locomotives lights on and off, you will need to change CV 29 to hex value “06” to have proper light operation when using the DT300 in its optimum 128 speed step mode.

Do this by programming CV29 with a hex value of “06”. See Table IV. Refer to Section 15.3 for complete programming instructions.

22.0 Troubleshooting Throttle Problems

See Section 21.0 above for general system troubleshooting tips.

22.1 Emergency Stop

If the layout starts to “get away” on you, either PRESS and hold the STOP Key



followed by the N- Key  or, turn the track power to “SLEEP” on the command station. Either way, the layout will stop to give you a chance to regain your composure. To resume operations where you left off, press and

hold the STOP Key  followed by the Y+ Key .

22.2 Nothing is responding

Is track power turned on? Is your throttle in Idle or stopped and displaying a flashing track power indicator in the LCD? Press and hold the STOP Key 

followed by the Y+ Key . You should see the track power indicator on the DT300 and on your command station come on.

22.3 Can't select a loco address on my throttle

Is the loco in use by another throttle (did the throttle ask you “STEAL=Y?”).

Is the loco part of a consist (do you see a cn in the display when you try to select it)?

Do the settings in CV29, the configuration register, match the command station output? If your decoder is a 14 step decoder running on any Digitrax system using factory defaults, status editing will be needed for that decoder.

Have you reset any CVs since the last time you ran the loco? If so, go back and change them to their default CV values and then try to run the loco. It is possible to set acceleration so high that it will take 10 minutes for the loco to start moving.

Does your throttle say “slot=max” ? This means that the system's capacity to handle operating locos is full. The DCS100 can run up to 22 or 120 addresses at the same time. If you have the “slot=max” message, be sure that all locos that are not running are released from throttles or set DCS100 OpSw 44 to closed to increase the number of addresses to 120. The DB150 command sta-

tion that comes with Empire Builder II & Genesis II sets have a system limit of 22 addresses.

Was the loco running normally just before it stopped? If the decoder is very warm it may be in thermal shutdown. Let it cool off and see if it starts again. Also check for localized track problems.

Are there burn marks on the decoder? You'll need to send it in for repair! If all else fails, reprogram the decoder address and reset CVs to default values.

23.0 Tetherless Operation of DT300/R

The DT300 that comes with every Chief II set is “InfraReady”. If your Chief II is radio equipped, it came with a DT300R Radio Throttle. A 9 volt battery must be used to power the DT300/R for tetherless operation. Using DT300/R as a tetherless throttle is easy:

1. For Infrared operation, plug in at least one Digitrax IR receiver (UR90 or UR91) to your working LocoNet. Because infrared signals are line of sight, more than one receiver may be necessary for optimal performance in your layout room. See Section 27 for more information about installing UR90 and/or UR91s on your layout.
2. For Radio operation, plug in at least one Digitrax Radio receiver UR91 to your working LocoNet. Most layouts only need one UR91.
3. Install a 9 volt battery in your DT300/R. See Section 24.0 for battery installation information.
4. Plug your DT300/R in to LocoNet and it will verify that at least one infrared and/or radio receiver is connected to LocoNet. The throttle will display either rA or Ir (depending on whether it finds an infrared or radio receiver first) followed by the current LocoNet ID. This example shows that the DT300/R has detected an infrared receiver and that the current LocoNet ID is 03. The throttle has loco addresses 03 & 1280 selected.

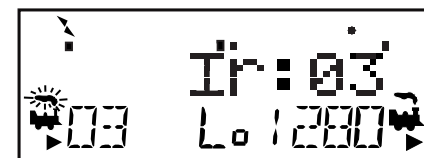

5. The DT300/R will then log on to the LocoNet ID of the LocoNet it was plugged in to and will begin to operate as an IR throttle when you unplug it from LocoNet. When you unplug from LocoNet, the tetherless indicator will come on and the tetherless message will dis-

play for a few seconds indicating whether the throttle is running as Ir (infrared) or rA (radio). It will also display the LocoNet ID that the throttle is logged on to,

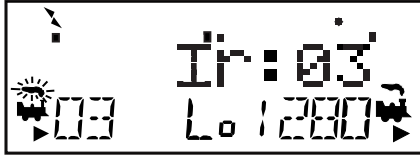

followed by a normal Lo mode display with the tetherless indicator lit.



23.1 Power Save Mode

If an untethered DT300/R, operating as a tetherless throttle, detects no user throttle activity for about 3 minutes it will enter power save mode. The display will show:



The throttle may flash the normal Lo (Loco) Mode screen about every 60 seconds. This happens when the throttle “pings” the system to let the command station know that it is still part of the system. This keeps the system from releasing that locomotive back to the system and making it available to be selected by another throttle.

Any key strokes or movement of the throttle knobs will bring the DT300/R out of power save and return to the normal Lo (Loco) mode screen.



Fast clock caution: If you use power save mode, the DT300/R’s local fast clock copy will deviate from the LocoNet system clock. The fast clock will re-synchronize with your LocoNet system fast clock when it is plugged in again.

23.2 LocoNet ID Change

Your DT300/R will log on to the LocoNet ID offered by compatible infrared or radio receiver it sees when plugged in to LocoNet. The default LocoNet ID is 00. It may be necessary to change the LocoNet ID if more than one club is

operating in close proximity at a train show so that the commands sent by one club will not interfere with the commands sent by other clubs.

To change a LocoNet ID:

1. Disconnect a DT300/R from the LocoNet for which you want to change the LocoNet ID.
2. Press and hold down the MODE Key  on the DT300/R and then plug it back in to LocoNet. Release the MODE Key  after plugging in.
3. The DT300/R will display the current LocoNet ID “Ir:0n”, where “n” is the current LocoNet ID. Use either throttle knob to change the LocoNet ID. You can set the LocoNet ID to be any number from 0 to 7.
4. Press SEL Key  to set the system to the new LocoNet ID.
5. The DT300 used to change the LocoNet ID will automatically log on to the new LocoNet ID.
6. Unplug and reconnect any other DT series infrared or radio throttles that will be used on this system so that they can log on to the new LocoNet ID number and be able to operate on the system.

If you add a new UR90 or UR91 to the system and are using a LocoNet ID other than the initial default value of 0, you must to re-synchronize the IDs in all the UR90s and UR91s by setting the LocoNet ID as described above.

If you are operating in an area where more than one LocoNet systems is operating nearby, be sure to coordinate with other layouts so that each one has its own unique LocoNet ID before beginning operations.

23.3 Tetherless Operation

Selecting a Locomotive-Safety Selection

While tetherless, the DT300/R operates as a one-way transmitter. The DT300/R must be plugged into LocoNet to select an available locomotive address. After an address is selected on your DT300/R, you can unplug from LocoNet and run the selected addresses with infrared or radio. The throttle will automatically convert to infrared or radio operation for all speed, direction, function, operations mode programming, and switch commands.

Digitrax uses a safety selection procedure that requires throttles to be plugged in to LocoNet to select a loco address to run. This is an important operational safety feature. Digitrax chose not to allow one way address selection to prevent multiple operators from being able to select and send commands to the

same addresses at the same time. Having multiple operators sending commands to the same address can result in serious problems in an operating session because locos can appear to be out of control.

Releasing a Locomotive

Two options are available for tetherless release. These options are set by DT300 Option #3, see Section 25.0 for instructions.

No tetherless release allowed: if the SEL Key  is pressed while the DT300/R is running in tetherless mode, the addresses selected will not be released unless the throttle is plugged in to LocoNet. This is the factory default.



Tetherless release allowed: if the SEL Key  is pressed while the DT300/R is running in tetherless mode, the address selected on that side of the throttle will be released immediately and that throttle will become inactive. To re-select this loco address plug your DT300/R in to LocoNet and select the loco address on the throttle.

Multiple Unit Operations

Consists must be assembled and broken up while the DT300/R is plugged in to LocoNet. MU operations are locked out while the DT300/R is running tetherless. Once a consist is assembled, it can be operated normally using the DT300/R in tetherless mode.



Programming

Ops mode programming is the only programming method that will work while the DT300/R is operating as a tetherless throttle. If you press and hold the STOP

Key  followed by the FN F0 Key  to enter programming mode, the DT300/R running as tetherless will default to the Po mode (ops mode programming). The DT300 must be connected to LocoNet to use service mode programming.

Switch Mode

The DT300/R will operate in “Switch” Mode while tetherless. It can operate

turnouts and routes using the L Reverse “t”  & R Reverse “c” Keys  in the normal manner.

Ballistic Tracking

While running tetherless, ballistic tracking will feel slightly different than while connected to LocoNet.

Fast Clock



When using the fast clock option, the DT300/R will keep track of and display fast time based on the last synchronized system fast time when the DT300/R was connected to LocoNet. If the fast time is edited by another throttle connected to LocoNet, the DT300/R will not see this change until it is plugged into LocoNet at which time its display will be updated.

23.3.1 Keyboard Lock



While the DT300/R is being used tetherless, there are occasions when you may want to disable the throttle’s keyboard to prevent accidental commands being sent to the railroad. For example, your train is in a siding waiting for another train to pass. You put your throttle in your pocket and go take a break. By locking the keyboard, you will not be able to accidentally start your train if you

bump your throttle or press the Y + Key .

To lock the keyboard on your DT300

1. Press both the Y +  and the N -  Keys at the same time.
When you are locking the keyboard be sure to press both the Y+ & N- Keys AT THE SAME TIME to avoid sending a speed command to the active loco.
2. The throttle will display “Lock=+&-” in the display and none of the controls will function until you unlock the keypad.

To un-lock the keyboard

1. Press both the Y +  and the N -  Keys at the same time again. This will return the throttle to normal operation.
2. Plugging the throttle into LocoNet will also unlock the throttle.

24.0 DT300 Battery

24.1 Battery Installation

For normal tethered operation, the DT300 does not need a battery. If you want to use your DT300/R as an infrared or radio throttle, you must install a 9 volt battery. When you install the battery, the throttle will report the battery voltage and then display Idle. Once you plug in to LocoNet, DT300s will begin operating infrared and DT300Rs will begin operating as radio throttles.

We recommend that you remove the battery from throttle if it is unplugged

from the system to conserve battery life.

Batteries can be stored inside the DT300/R by removing the battery and putting it back in the battery compartment with the polarity reversed.

24.2 Low Power Indicator

While it is running as a tetherless throttle, the DT300/R automatically checks the power available to the throttle each time a battery is inserted and each time it is plugged into or unplugged from LocoNet. The power from the battery or from LocoNet will be displayed in the text area of the throttle briefly each time the throttle is plugged in or is unplugged from LocoNet.

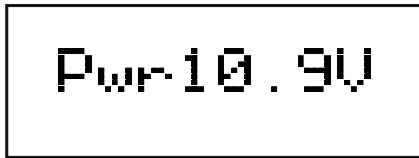

When you plug in to LocoNet the number displayed will be the power provided by LocoNet. This value will be between 9 & 15 volts.

When you insert a battery or unplug from LocoNet, the value displayed will be the battery power. When this number is less than 6.2 V you may want to consider changing the battery. The DT300/R will still continue to operate reliably for an extended period of time depending on the type battery is in use. 9 volt alkaline batteries are nearing the end of their life at 6.8 volts, but 7.2 volt NiCad rechargeable batteries may still have lots of life remaining. Experience will determine how long your DT300/R will operate with the batteries you are using.

Diagram 8: DT300/R Battery Installation

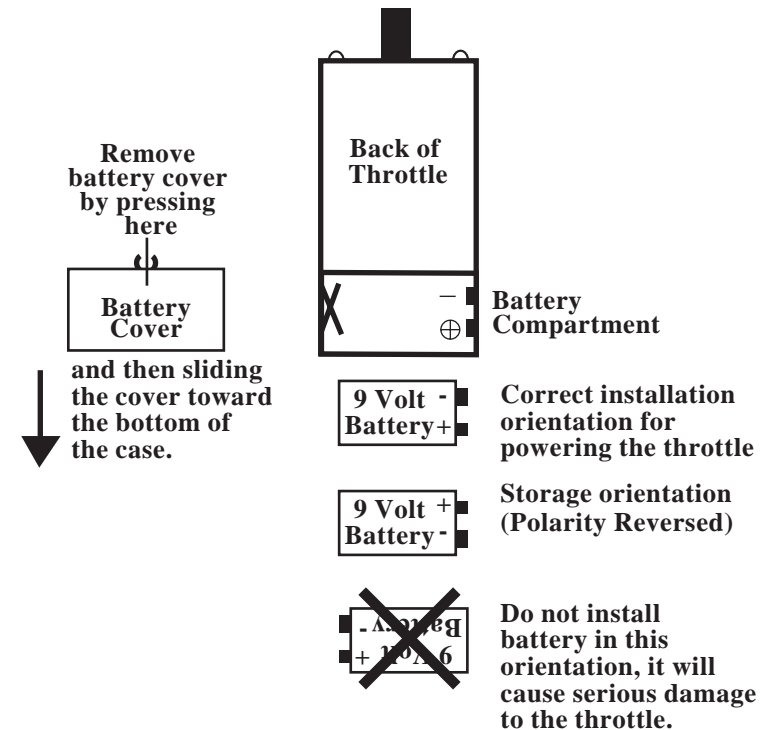

24.3 Battery Replacement

When the battery is not supplying enough power to run your throttle in tetherless mode, you will see your throttle display “Idle”. When this happens, plug in to LocoNet and complete any jobs you had in progress. Loco addresses selected on your throttle will continue running until you plug in and bring them to a stop. Loco addresses selected will not be “lost” when the battery goes down. Install a fresh battery and then you can unplug again and resume tetherless operation.

25.0 Customizing Your DT300



You can set up the following options for each DT300 throttle to customize the way it operates.

You can choose between ballistic and normal tracking, whether the fast clock is displayed, whether the keys and knobs click when you operate them, whether a STOP command is local or global, how the throttle handles new decoders, how

tetherless operation works, the brightness of the backlight in the display, whether the clock is in 24 or 12 hour format, the depth of the recall stack, the throttle ID#, and which radio frequency the throttle will use.



To make these changes, consult the following tables to determine which option values to set up in Option #1, Option #2, Option #3, Option #4, Option #F & Option #6.

To change DT300 Option Settings:

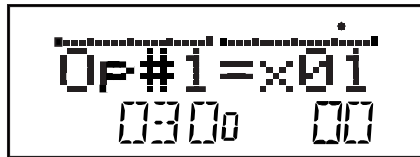
1. Consult the tables below to determine which settings you want to make for each of the 6 available option tables.
2. Release all locos selected on the throttle before you begin.
3. Unplug the DT300 from LocoNet.
4. Press and hold the SEL Key  while plugging the DT300 back into LocoNet. You can also enter option setting by holding down the SEL Key  while installing a battery in your DT300 while it is not connected to LocoNet.





The illustration above shows DT300 Option #1 set at x01.

5. The DT300 display will show OP#1=???. The ??? in the right side of the display will show the current setting for OP#1. **The default setting for OP#1 is x01.** This display will appear for about 5 seconds, if no action is taken after 5 seconds, the DT300 will return to Lo (Loco) mode.
6. While OP#1=??? is in the display, use the throttle knobs “R or L” to set the option value selected from Table VI for OP#1.
7. Press the SEL Key  to set OP#1 and advance to OP#2=???.
8. Dial in the value selected from Table VII for OP#2 (**OP#2 default for DT300=x23, OP#2 default for DT300R=x03**) and press the SEL Key  to advance to OP#3=???.
9. Dial in the value selected from Table VIII for OP#3 (**OP#3 default=x01**) and press the SEL Key  to advance to OP#4=???.

10. You should not need to change the values for OP#4, OP#F or OP#6 so press the SEL Key  three more times to step through these options or wait for about 6 seconds for the throttle to time out and go into Lo or Loco Mode.

25.1 Ballistic or Straight Line Tracking

With ballistic tracking, the faster you increase or decrease the the throttle knob, the faster the data changes in the throttle. When ballistic tracking is enabled, so are typematic keys. With typematic keys, when you press and hold the Y +  or N -  Keys, the values will continue to increase or decrease without having to do a separate key press for each increment. Your DT300 was shipped with ballistic tracking as the factory default setting.

With straight line tracking each movement of the throttle knob causes a fixed rate of change. When you use straight line tracking, typematic key action is off. This means that you must press each key once to cause an action.

25.2 Fast Clock Display On/Off

DT300 can be set up to display the fast clock or not to display the fast clock. Your DT300 was shipped with fast clock display disabled.

25.3 Key & Knob Clicks On/Off

DT300 can be set up to click each time you press a key or turn one of the knobs. Some users like to have this auditory feed back and others don't. Your DT300 was shipped with key & knob clicks enabled.

25.4 STOP Local or Global

The STOP Key  can be set up so that pressing it causes either a

1. Local emergency stop which stops only the loco addresses selected on that particular DT300 or
2. Global emergency stop which will cause all loco addresses on the layout to execute emergency stop.

Table VI: DT300 Throttle Option #1 Choices

Op#1 Value	Options Enabled			
	Ballistic Tracking & Typematic Keys	Fast Clock Display	Key & Knob Clicks	Run/Stop Local/Global
00	No	No	Yes	Local
01 (Default)	Yes	No	Yes	Local
02	No	Yes	No	Local
03	Yes	Yes	Yes	Local
04	No	No	No	Local
05	Yes	No	No	Local
06	No	Yes	Yes	Local
07	Yes	Yes	No	Local
10	No	No	Yes	Global
11	Yes	No	Yes	Global
12	No	Yes	No	Global
13	Yes	Yes	Yes	Global
14	No	No	No	Global
15	Yes	No	No	Global
16	No	Yes	Yes	Global
17	Yes	Yes	No	Global

25.5 Throttle Default Decoder Operation

Each DT300 can be set up to operate new decoders selected by them as any decoder status code you choose. New decoders are defined as decoders that have not been selected in your system. Your DT300 is set to expect to operate mostly decoders that are 128 speed step capable, so when a new decoder is selected the DT300 defaults to that status code. If you operate mostly decoders that are only able to recognize 28 speed steps, you can change this setting.

25.6 Tetherless Operation Mode

Each DT300 can be set up with radio capability and/or infrared capability enabled, all tetherless operation disabled and power save enabled or disabled.

25.7 LCD Backlight Brightness Setting

The backlight intensity can be set for off, low, medium or high intensity. The brightness of the backlight affects battery life, the brighter the LCD, the shorter

the battery life. **Note: When the DT400 is untethered, the backlight automatically reduces brightness by one setting to conserve battery power.**

25.8 Fast Clock Format

The fast clock can be set up to run in 12 hour format or 24 hour format.

25.9 Recall Stack Depth

The DT300 recall feature can be set to keep a list of the last 4, 8, or 16 addresses that were selected in the throttle.

Table IV: DT300 Throttle Option #2 Choices

Op#2 Value (hex)	Throttle Default For Decoder Operation	Tetherless Operation Mode
x00	28 step decoder	Radio & IR
x02	14 step decoder	Radio & IR
x03 (DT300R)	128 step decoder	Radio & IR
x20	28 step decoder	IR Only Enabled
x22	14 step decoder	IR Only Enabled
x23 (DT300)	128 step decoder	IR Only Enabled
x24	28 step FX decoder	IR Only Enabled
x27	128 step FX decoder	IR Only Enabled
x28	Disable default decoder operation override	IR Only Enabled
x40	28 step decoder	Radio Only Enabled
x42	14 step decoder	Radio Only Enabled
x43	128 step decoder	Radio Only Enabled
x44	28 step FX decoder	Radio Only Enabled
x47	128 step FX decoder	Radio Only Enabled
x48	Disable default decoder operation override	Radio Only Enabled
x60	28 step decoder	IR & Radio Disabled
x62	14 step decoder	IR & Radio Disabled
x63	128 step decoder	IR & Radio Disabled
x64	28 step FX decoder	IR & Radio Disabled
x67	128 step FX decoder	IR & Radio Disabled
x68	Disable default decoder operation override	IR & Radio Disabled
x80	28 step decoder	Disable Power Save
x82	14 step decoder	Disable Power Save
x83	128 step decoder	Disable Power Save
x84	28 step FX decoder	Disable Power Save
x87	128 step FX decoder	Disable Power Save
x88	Disable default decoder operation override	Disable Power Save

Table VIII: DT300 Throttle Option #3 Set Up Choices

Op#3 Value	Backlight Brightness	Clock Format	Recall Stack Depth	Tetherless Release
00	Off	12 hour format	4	No
01	Low intensity	12 hour fmt	4	No
02	Medium intensity	12 hour format	4	No
03	High intensity	12 hour format	4	No
04	Off	24 hour format	4	No
05	Low intensity	24 hour format	4	No
06	Medium intensity	24 hour format	4	No
07	High intensity	24 hour format	4	No
08	Off	12 hour format	4	Yes
09	Low intensity	12 hour format	4	Yes
0A	Medium intensity	12 hour format	4	Yes
0B	High intensity	12 hour format	4	Yes
0C	Off	24 hour format	4	Yes
0D	Low intensity	24 hour format	4	Yes
0E	Medium intensity	24 hour format	4	Yes
0F	High intensity	24 hour format	4	Yes
10	Off	12 hour format	8	No
11	Low intensity	12 hour format	8	No
12	Medium intensity	12 hour format	8	No
13	High intensity	12 hour format	8	No
14	Off	24 hour format	8	No
15	Low intensity	24 hour format	8	No
16	Medium intensity	24 hour format	8	No
17	High intensity	24 hour format	8	No
18	Off	12 hour format	8	Yes
19	Low intensity	12 hour format	8	Yes
1A	Medium intensity	12 hour format	8	Yes
1B	High intensity	12 hour format	8	Yes
1C	Off	24 hour format	8	Yes
1D	Low intensity	24 hour format	8	Yes
1E	Medium intensity	24 hour format	8	Yes
1F	High intensity	24 hour format	8	Yes

**Table VIII: DT300 Throttle Option #3 Set Up Choices
(Continued)**

Op#3 Value	Backlight Brightness	Clock Format	Recall Stack Depth	Tether-less Release
20	Off	12 hour format	16	No
21	Low intensity	12 hour format	16	No
22	Medium intensity	12 hour format	16	No
23	High intensity	12 hour format	16	No
24	Off	24 hour format	16	No
25	Low intensity	24 hour format	16	No
26	Medium intensity	24 hour format	16	No
27	High intensity	24 hour format	16	No
28	Off	12 hour format	16	Yes
29	Low intensity	12 hour format	16	Yes
2A	Medium intensity	12 hour format	16	Yes
2B	High intensity	12 hour format	16	Yes
2C	Off	24 hour format	16	Yes
2D	Low intensity	24 hour format	16	Yes
2E	Medium intensity	24 hour format	16	Yes
2F	High intensity	24 hour format	16	Yes

Option # 4 sets the throttle ID of your throttle. Each throttle in your LocoNet system has its own unique ID. We do not recommend changing this ID but if you choose to do so, the range of values 00-FF (hex) and you must be sure that every throttle in your system has a unique ID #.

Option #F sets the radio frequency used by the throttle when in radio mode. This setting is x0A. This value is informational only, users are not able to change this value.

Option #6 sets the throttle type. All DT300s are throttle type x33. You should not change this value.





26.0 DCS100 Option Switch Setup

The DCS100 has many customizable system operation options that you can set to customize your operation. The DCS100's power up defaults are fine for most applications and the DCS100 will run "out of the box." The factory default setting for all DCS100 option switches is "t" or thrown. We recommend that you change Option Switch OpSw 05 to "c" or closed. This will not affect your operations, it will just make diagnostics easier to do.

The internal battery backed CMOS memory will hold these settings for a year or more in normal usage. When your battery is low, an alarm will sound to let you know that it's time for a new battery. You will be able to "hot" change the battery so that none of your system settings are lost. See Section 5.14 for DCS100 CMOS battery information. The power fault/ battery fail "clean restart" for all DCS100 option switches is "t" or thrown.

The factory default setting for all DCS100 option switches is "t" or thrown.

Changing DCS100 Option Switches

1. See the DCS100 Option Switch Table below to decide which option switches you want to change.
2. Move the MODE toggle switch on the front of the DCS100 into the "OP" position . The LocoNet Railsync will go inactive & all other boosters plugged in to LocoNet, including the one that is built into the DCS100, will shut down.
3. Disconnect LocoNet from the DCS100 you are configuring.
4. Connect your DT300 throttle directly to either DCS100 LocoNet port A or B.
5. Press the MODE Key  on the DT300 to enter Sw (Switch) mode. Since the DCS100's MODE toggle switch is set to "OP", switch commands from your throttle will now control DCS100 option switch settings instead of the accessory decoders (usually turnouts) on the layout!
6. Use the R Throttle knob to dial in the OpSw you want to change. As you browse through the OpSws, the right side of the text area will show the current setting for each OpSw, either "c" or "t".
7. Use the R Reverse Key  to set the OpSw to c (closed) or the L Reverse Key  to set the OpSw to t (thrown).
8. Exit DCS100 Option Switch Mode by moving the MODE toggle

switch on the DCS100 to RUN . Remember to reconnect LocoNet to the DCS100.

Do not adjust any Op Switches marked “Do Not Change” These option switches are reserved and changing them may give unpredictable operations. Do not changes any option switches not listed in the table below.

*Special Instructions for DCS100 Op Switches 36, 37, 38, & 39
For Op Switch #36-#39 to work properly,



1. Set the OpSw to “c” by pressing the R Reverse Key.
2. Set the DCS100’s MODE Switch to “SLEEP” mode .
3. Set the DCS100’s MODE Switch back to “RUN” mode .
4. The operation will occur (data will be cleared) and the option switch will reset to “t”.
5. Your DT300 display will still show “c” even though the reset has occurred.
6. The display will update the next time you access the OpSw.

Table IX: DCS100 Option Switch Table

Option Switch #	Effect on System operation when "closed"	Def
OpSw 01	Do Not Change	t
OpSw 02	Do Not Change ("c" setting makes DCS100 a booster)	t
OpSw 03	DCS100's booster is auto reversing	t
OpSw 04	Do Not Change	t
OpSw 05	Command station master mode (We recommend this be changed to c)	t
OpSw 06	Do Not Change	t
OpSw 07	Do Not Change	t
OpSw 08	Do Not Change	t
OpSw 09	Allow Motorola trinary switch packet command echo for switches 1-256.	t
OpSw 10	Expand trinary switch echo range from 1 -64 to 1-256, when OpSw 09 is "c"	t
OpSw 11	Make trinary switches 57-64 long duration (1 sec) ON period, when OpSw 09 is "c", use for uncouplers, etc.	t
OpSw 12	Motorola trinary/AC digital mobile deco der addresses 1-80 allowed. (User must status edit loco types to "x1")	t
OpSw 13	Loco address purge time extended from 200 seconds to 600 seconds	t
OpSw 14	Loco address purging disabled	t
OpSw 15	Purging will force a loco to 0 speed	t
OpSw 16	Do Not Change	t
OpSw 17	Automatic advanced decoder assisted [FX] consists are disabled	t
OpSw 18	Extend DCS100 booster short circuit shutdown time from 1/8th to 1/2 second	t
OpSw 19	Do Not Change	t
OpSw 20	Disable address 00 or analog stretching for conventional locos.	t

Table IX: DCS100 Option Switches (Continued)

Option Switch #	Effect on System operation when "closed"	Def
OpSw 21	OpSw 21-23 set the global system default type for "NEW" loco selections.	t
OpSw 22	SW21/22/23 set as follows: t-t-t=3 128 step mode t-t-c=7 128 step FX mode t-c-t=1 Motorola trinary format	t
OpSw 23	c-t-t=2 14 step mode c-c-t=0 28 step t-c-c=5	t
OpSw 24	Do Not Change	t
OpSw 25	Disable aliasing	t
OpSw 26	Enable routes	t
OpSw 27	Disable normal switch commands, a.k.a. the "Bushby bit." Allows attached PC to handle switch control logic	t
OpSw 28	Disable DS54 interrogate commands at power on	t
OpSw 29	Do Not Change	t
OpSw 30	Do Not Change	t
OpSw 31	Meter route/switch output rate when not trinary	t
OpSw 32	Do Not Change	t
OpSw 33	Allow track power to restore to prior state at power on	t
OpSw 34	Allow track to power up to run state, if set to run prior to power on	t
OpSw 35	Do Not Change	t
OpSw 36*	Clears all mobile decoder info & consists	t
OpSw 37*	Clears all routes	t
OpSw 38*	Clears the loco roster	t
OpSw 39*	Clears all internal memory states, including OpSw 36, 37 & 38 (see above)	t
OpSw 40	Do Not Change	t
OpSw 41	Diagnostic click when valid LocoNet commands incoming & routes being output	t
OpSw 42	Disable 3 beeps when loco address purged	t

Table IX: DCS100 Option Switches (Continued)

Option Switch #	Effect on System operation when "closed"	Def
OpSw 43	Disable Loconet update of command station's track status	t
OpSw 44	Expand slot refresh area from 22 (Big Boy compatible) to 120	t
OpSw 45	Disable reply for switch state request	t
OpSw 46	Do Not Change	t
OpSw 47	Program track is brake generator when not programming. Braking is DCC set to speed 0 (not Emergency stop) for address 0, light ON, broadcast to all addresses	t

27.0 IR & Radio Receivers UR90 & UR91

To use your DT300 as an infrared throttle you must install one or more infrared receivers on LocoNet. To use your DT300R as a radio throttle, you must install at least one radio receiver on your LocoNet. It is a good idea to also install enough LocoNet jacks around the layout for normal walkaround operation with tethered throttles. The LocoNet jacks are also used by tetherless throttles for selecting loco addresses to run, setting up and maintaining consists, service mode programming. Also, if a tetherless throttle loses control of the loco address it is running or if the throttle battery goes dead, the operator will need to plug in to a LocoNet jack to recover.

27.1 Powering UR90 & UR91 Receivers

For best operation, UR90, UR91 & all UP panels should be powered with a 12V DC external power supply such as the Digitrax PS12. You can run up to 5 UP or UR panels with a single 12-15V DC power supply. The UR91 absolutely must be powered with a 12V DC supply. UR91 & UP Panels can use local track power by connecting the screw terminals on the back of the units to rail A & B of the local track section. If you use local track power, this will impact the power available to run more locos since part of that energy will be used to power the UP/UR panels. We recommend that you power your UPs & URs as shown in Diagram 9.

27.1.2 UR90/UR91 Track Status Indicator

Note: Hooking up the UR90 & UR91 Track Status Indicator is OPTIONAL. The UR's Track Status Indicator is a bi-color LED that shows the status of the local track section to which it is attached.

1. Attach an 18-26AWG wire to one of the screw terminals on the back of the UR & connect the other end to either rail.
2. Attach another 18-26AWG wire to the other screw terminal on the UR & connect it to the other rail of the track.
3. If you are hooking up more than one UR, be consistent in hooking up all track sections alike with respect to which terminal is connected to which rail. This is not required but strongly recommended.

As you operate your layout, the UR Track Status Indicator will be lit when the track is powered. The LED will glow red or green when you are operating an analog locomotive and the system is "zero stretching." When you are using DCC only, the LED will glow orange. This color change is a useful diagnostic tool.

Diagram 9: UP & UR Power

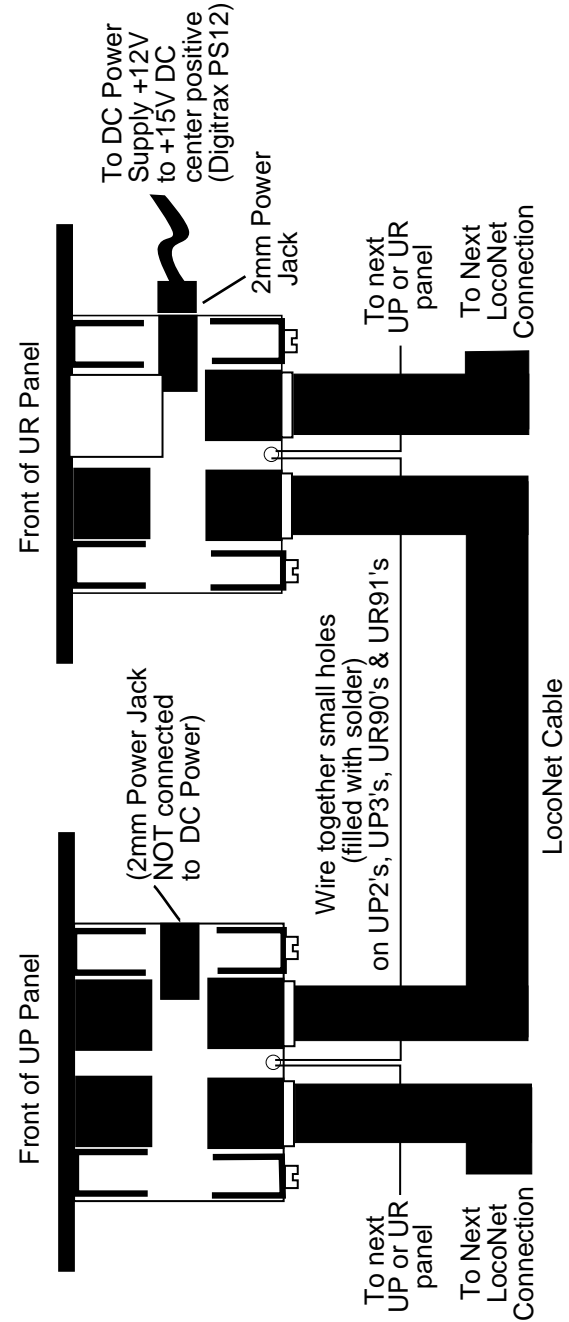

Note: You can run up to 10 UP or UR panels with a single DC power supply by connecting the small holes as indicated in this diagram.

27.2 Installation Basics UR90 & UR91

During installation of infrared or radio receivers, you will need to be able to see and/or hear your command station to be sure commands are being received via the UR panel. In the installation procedures detailed below, you will determine the best location/s in which to install UR90s and UR91s on your layout for optimal infrared or radio signal reception. You will need to make observations to determine when the system is receiving a signal and when it is not. Your Digitrax equipment gives you several ways you can make the observations. You should choose the observation method that works best with your layout. For example: on a small layout, you may be able to observe the command station directly. But on a large layout, it may be more convenient to set the command station to generate diagnostic clicks so you can hear when the system receives a command (see step 4 below for details).

1. On the DCS100, the red "NET" led will blink when a good LocoNet message is received by the DCS100.
2. With address 00 selected on the throttle and speed set to 99%, the TRACK STATUS indicator on the DCS100 or DB150 will change from red to green (or green to red) when you reverse the direction of address 00. Do this test without an analog loco on the track and you will still see the indicator color change. By removing the loco from the test environment, you can eliminate one more variable that might cause problems. If you can't see your command station everywhere on your layout, see step 3 below for a way to observe this effect.
3. Use your LT-1 as a local track testing tool. See the diagram below.
 - a. Twist together the black and blue leads.
 - b. Twist together the yellow and white leads.
 - c. Connect the black/blue leads to one rail and the yellow/white leads to the other rail of any section of track.
 - d. The two outside leds on the LT-1 will be lit.
 - e. Use your throttle to change the direction of address 00 that is set to 99% speed, one of the leds on the LT-1 will be brighter than the other.
 - f. Change direction again, the other led will be brighter.

This allows you to observe that the command station is receiving the tetherless throttle's command.

This tool can be carried with you as you move around the layout and will give a local indication that the radio or infrared signal is being received by the system without having to look at the command station for confirmation.

LT-1 Set Up As A Track Tester

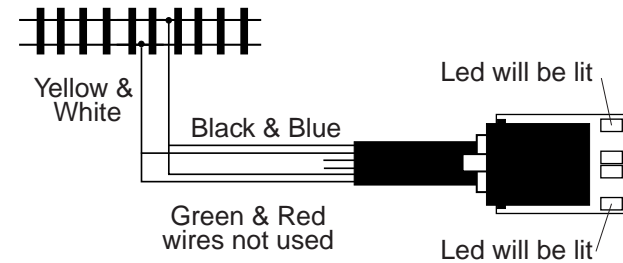

You can also use a bi-color led indicator lamp, with a 500 to 1k ohm resistor in series, connected to the two rails of the powered track.

4. Set your command station's Option Switch #41 to closed to generate a diagnostic "click" sound each time it receives a good LocoNet message. See the DB150 or DCS100 Option Switch Setup Section in this manual for information about changing this options switch. This has no effect on command station operation except that it causes the diagnostic clicks. Once you have finished installing the UR 90 or 91, set OpSw#41 back to thrown and the clicking will be disabled.

27.3 UR90 Infrared Receiver Installation

Many customers simply plug in one or more UR90s around the layout and begin experimenting to decide where to install additional units to get the best IR reception. The following installation procedure is more organized and may save you money by helping you install fewer UR90s to get adequate coverage.

Since infrared operation depends on line of sight, UR90s must be located so that the IR signals from the throttles will be "seen" by the UR90. Reflective walls and ceilings will help IR reception however, more than one receiver may be necessary for full coverage of your layout.

1. Decide how you will observe whether signals are being received. See Section 27.2 above.
2. Remove all locomotives from the layout and turn off the power to the system.
3. Plug your UR90/s into LocoNet jacks near where you think will be the best installation location. Remember that infrared is line of sight when deciding on possible installation locations.
4. Provide power for the UR90/s according to Section 27.1 above.
5. Power up the layout and track.

6. Install a 9 volt battery in your DT300 and plug it in to LocoNet. the DT300 will automatically detect the UR90 and allow infrared operation when the throttle is unplugged from LocoNet.
7. While still plugged in, use the DT300 to select loco address "00" and run it at 99% speed. (Since there are no locos on the track, nothing is actually running. We will use this as a diagnostic to help determine the best location/s for your UR90/s for optimal infrared reception.
8. Change the direction of address "00" by pressing the Reverse Key or double clicking the throttle knob associated with address 00. Observe whether the signal was received by the system by the color change on the command station's TRACK STATUS indicator or other method chosen from Section 27.2.
9. Unplug the DT300. Move around the layout area stopping to test at several locations. At each location, change the direction of address "00" and observe that the command was received by the system. Slowly rotate in place at each test location to check reception from various directions. By moving around the whole layout area, you will be able to determine whether any infrared "blind spots" exist.
10. When you locate blind spots, adjust the location of the UR90s until you have good reception everywhere in the room.
11. Once you have determined the installation locations that give the best reception, you can permanently mount the UR90s and hook up the wiring under the layout.

27.4 UR91 Radio Receiver Installation

The following procedure will help you determine the best location on your layout for installation of your UR91.

1. Decide how you will observe whether signals are being received. See Section 27.2 above.
2. Remove all locomotives from the layout and turn off the power to the system.
3. Gently straighten the UR91's two small flexible antennas so that they are pointing up from the PC Board. Spread the 2 antennas about 20 degrees apart. Be sure not to bend the green antenna wires too many times as this could cause damage. Do not allow the UR91 antennas to connect to bare conductors or layout wiring. It is good practice to keep other wires below the antenna level and about 1-2 feet away from them.
4. Plug the Digitrax PS12 +12 volt DC power supply into the 2.0 mm power jack on the side of the UR91. See Section 27.1 above for more information about providing power to your UR91.
5. Plug the UR91 into a LocoNet jack near where you plan to install it. We recommend that you start with a central location that will likely

provide best coverage.

6. Power up the layout and track.
7. The Green LED on the UR91 will be lit indicating the UR91 has passed its internal self-tests and is ready to receive radio signals.
8. Install a 9 volt battery in your DT300R and plug it in to LocoNet.
9. While still plugged in, use the DT300R to select loco address "00" and run it at 99% speed. (Since there are no locos on the track, nothing is actually running. We will use this as a diagnostic to help determine the best location for your UR91 for optimal radio reception.
10. Change the direction of address "00" by pressing the Reverse Key or double clicking the throttle knob associated with address 00. Observe whether the signal was received by the system by the color change on the command station's TRACK STATUS indicator or other method chosen from Section 27.2.
11. Unplug the DT300R. Move around the layout area stopping to test at several locations. At each location, change the direction of address "00" and observe that the command was received by the system. Slowly rotate in place at each test location to check reception from various directions. By moving around the whole layout area, you will be able to determine whether any radio "blind spots" exist.
12. When you locate blind spots, adjust the location of the UR91 until you have good radio reception everywhere in the room.
13. Once you have determined the installation location that gives the best reception, you can permanently mount the UR91 and hook up the wiring under the layout.

The UR91's green RADIO led indicator on the UR91 will flicker as it receives a good radio message from the DT300R. This indicates that the radio link is working properly.

Troubleshooting Tip: If the green RADIO led flickers but there is no response from the command station or loco address, you probably have a plug crimped in the reverse orientation on one of the LocoNet cables. You should test all LocoNet cables using your LT-1 to avoid this problem. To correct the problem, just cut off the reversed plug and re-crimp a new one in the correct orientation. You can also eliminate this problem by splitting the insulation on any LocoNet cable and shorting the two center wires (red and green) together. Make sure that the shorted wires continue through the cable as before.

27.4.1 Resolving Radio Reception Problems

Most layouts don't experience problems with radio reception but, if you are having trouble, try the following suggestions for improving reception.

1. Electrical wiring, metal plumbing and A/C ducting and other items may cause areas of poor reception around the layout. This is typically due to the multi-path reflections or echoes of the radio waves. Moving the DT300R about 6" to 12" in any direction or varying the orientation of the DT300R will usually overcome any blind spots. Another option is to re-locate the UR91. Sometimes a more central location is better, other times moving the UR91 to a completely different area is the answer. Since every layout is different, this will be a matter of trying different locations until you find the right one for your particular situation.
2. Adjust the two antenna wires on the UR91 from the recommended vertical "V" orientation to a horizontal orientation. This orientation gives better reception of horizontal polarization that may be experienced in some buildings with metal floors and roofs. Changing the UR91 antennas will **not** lead to improved range performance.
3. If adjustment of UR91's location and antenna wires does not clear a stubborn dead spot or range problem, consider adding a second UR91 installed away from the first UR91 to achieve better reception in the problem area. If you use more than one UR91 on the layout, they will automatically work together on LocoNet.
4. Note that the DT300R & UR91 share the radio spectrum with other types of radio services and might sometimes experience transient interference. If interference persists then consider using the DT300s in the tethered mode until the problem clears. You may turn off the DT300R radio option by modifying the DT300R Op#2 Value. See Section 25 for information on changing this setting.

28.0 Multi-Format Operation

Notes on concurrent Usage of Motorola Trinary type of Packets:

For the convenience of users with decoders & equipment that recognize the Motorola Trinary Format but that do not respond to NMRA DCC format, the DCS100 can generate these Trinary packets mixed in with normal DCC packets. Several companies build Command Control decoders that run on the Motorola format, for example Nacka, Marklin & several other European manufacturers.

For running Trinary Locomotives the user MUST "Status Edit" See Section 17.0.

The status code "tri" will force the DCS100 to address that decoder as a Trinary format decoder, e.g., Marklin AC digital HO or Maxi 1 Scale decoders.

Since the DCS100 is a multi-protocol command station there are several subtle issues that you need to be aware of when running in this mode.

1. Typically, trinary decoders have not been designed to operate in a multi-protocol environment, so there is no assurance that all trinary decoders will always behave predictably. Our experience has shown all trinary decoders reviewed to date work properly in this environment, but it is up to you, the user, to make this determination for your layout, conditions of usage & the decoders you are using.
2. Older trinary decoders can only operate with a fixed polarity of rail connections to the Booster. Be sure that no Boosters driving this mixed DCC/Trinary Protocol are set up for "auto reversing." This is particularly important for trinary switch decoders. The latest Marklin trinary "AC Digital" HO loco & Maxi loco decoders appear to allow operation with either rail polarity so if you are using these newer decoders auto reversing might not be a problem.

If any trinary decoder fails to respond when selected and the DCS100 is correctly set up to run in trinary mode by setting the DCS100's OpSw #s 09,10,11 &/or 12 as described in Section 25.0, check that the decoder rail connections are of the correct polarity. If they are wrong, swapping the rail/track feeds should correct the problem.

3. Trinary loco decoders should be stopped before reversing direction. In particular, the Marklin MAXI decoders will typically not reverse if the speed is above about 50%.
4. Be cautious mixing DCC & trinary loco's in consists. The trinary decoders do not have an "absolute direction" command. If they ever miss a direction change they will end up "fighting" the DCC decoders when the locos are physically linked. If you make up a consist, we recommend MU UNLINKING it before you power down the track, to avoid these problems. The DCS100 allows consisting of any DCC, Trinary & even the Analog address "00". Marklin trinary decoders can be "kept alive" with a small DC voltage bias, & this will ensure that they remember the last direction properly, if for example they encounter a Signal controlled Stop section where track power might be OFF. Refer to Marklin's decoder documentation on this keep alive.
5. If you have selected & operated only trinary decoders on your layout, the DCS100 will not generate any DCC packets. If a DCC decoder is placed on such a layout, it will typically "mode convert" to full speed DC operation, since it won't see any valid DCC packets. To

avoid this problem, you can disable Analog Mode conversion in CV29 of your DCC decoders. Alternatively, you can introduce a couple of "dummy" active DCC locomotive addresses which will keep unaddressed DCC decoders on the layout from mode converting if you choose not to disable their Analog Mode conversion feature.

6. When you are running an Analog loco without a decoder as address "00", addressing trinary loco decoders will tend to generate a small DC offset. This will cause the Analog loco to creep along even when its throttle is set at 0. The DCS100 compensates for a part of this effect, but it will still occur to a small degree.
7. If you select OpSw 09 to enable trinary switch addresses, the DCC commands are still sent for the switch range 1-256, & an extra timed echo is created for the trinary switch of the same address. The DCS100 times this Trinary switch range to ensure that an OFF code is sent to the Trinary switch decoder after about 1/2 second. Because of this the DCS100 employs a 8 deep Switch Command FIFO to buffer requests and DCC switch actions can be delayed from actual switch sections. If you leave OpSw 09 "thrown" to disable Trinary Switch echoing, then the DCC Switch commands are sent immediately.

29.0 Glossary

128 Speed Step Mode: the motor voltage/speed curve of the DCC loco from stop to full speed has 128 discrete speed steps. This means that you have 128 discrete speed steps at your disposal for excellent speed control, especially at very low speeds. 128 speed step operation will give a significant improvement in speed control over 14 or 28 step operation. 128 speed step operation is only offered in advanced and professional level DCC systems.

2 Digit Address: decoder address between 01 & 127 which is expressed as a 2 digit number. Addresses above 99 are expressed as hexadecimal numbers. The DT300 translates these numbers into three digit numbers 100-127. Technically a 2 digit address is a 7 bit address and is the baseline packet format for DCC addresses. It is sometimes called the short address.

4 Digit Address: decoder address between 0128 & 9983. Not all 4 digit addresses in this range are actually available for use. Your DT300 can access 0128 through 9983. Digitrax handles addresses below 0128 as two digit addresses to avoid confusion. Technically a 4 digit address is a 14 bit address and is considered an extended packet format DCC decoder address. Sometimes

this is called the long address.

+: plus or add, used to increase speed or other numbers in DT300 display. Also used to add loco addresses to consists.

-: minus or remove, used to decrease speed or other numbers in the DT300 display. Also used to remove loco addresses from consists.

AC or Alternating Current: An expression used to describe an electrical wave form that cycles or alternates above and below 0 volts. In the U.S., household electricity is 60 cycle, alternating 60 times a second, 110-120 volts.

Acceleration: The rate at which the decoder increases from one speed step to the next in response to a new increase speed command. Use CV03 to set this value for each decoder. This feature is used to simulate train weight and to cause your model to respond more prototypically when you increase the throttle.

Active throttle: Digitrax DT throttles are actually two throttles in one. Each handheld can control two different addresses or consists at a time one on the right side or R Throttle and the other on the left side or L Throttle. The DT's display is shared by the two sides of the throttle. The side for which information is currently in the display is called the active throttle.

Address, Decoder: an identifying number programmed into a particular mobile or stationary decoder. The DCC system uses the decoder address to send commands to the appropriate loco or accessory decoder.

Address Range: Analog address range is 00. 2 digit address range is 01-127, 4 digit address range is 0128-9983. Each DCC system also has a range of addresses available for use by the operators. Genesis II has an address range of 00-99 and can run up to 22 addresses at a time. Empire Builder II has an address range of 00-9983 and can run up to 22 addresses at a time. Super Chief & Chief II have an address range of 00-9983 and can run up to 120 addresses at a time.

Advanced (EPF) Consisting Method: consist information is stored in each decoder. Locos can be added to and deleted from the consist in any orientation. This method requires that all locomotives in the consist be equipped with decoders that support this feature (EPF decoders). This method lets you set up a consist that is "transportable" from one DCC layout to another. The problem is that you must be sure to put the locos back on the track in the same order and orientation you programmed them for or you can get some unexpected results.

Advanced Mode (28 Speed Step Mode): the motor voltage/speed curve of the DCC loco from stop to full speed has 28 discrete speed steps. This means that speed control will be limited to 28 steps. 28 speed step mode gives fine speed control. Increasing to 128 speed step operation gives a significant improvement in speed control, especially at very slow speeds needed for prototypical switching. Advanced mode is offered in most command stations because there are decoders on the market that are not capable of 128 step mode operation.

Analog Loco: A locomotive operating on a DCC layout without a DCC decoder installed. Also called a Conventional Loco.

Analog Mode Conversion: When a Digitrax decoder does not see DCC packets on the layout it changes automatically to DC operation. Not all DCC systems support this feature so you may have to program non-Digitrax decoders to operate on analog layouts. Automatic analog mode conversion can be disabled by programming CV29.

Autoreversing: a feature of Digitrax boosters that allows a train to enter and exit reversing sections automatically without the need for the operator to throw a switch to match track polarities on either side of the reversing section.

Ballast Lamp: For use as a buffer between DC and DCC track sections, a ballast lamp is connected across one of the double gaps separating the two track sections. For most model railroad applications a 12 volt automobile brake lamp wired in series for this purpose.

Basic Consisting Method: Program all the locomotives in a consist to the same address and run them on one throttle. In this case all the locos must be running in the same direction unless you have set up normal direction of travel as reverse or have rewired the motor on locos that you want to run “backwards” in the consist.

Booster: Boosters receive the DCC signal from the Command Station, amplify it & put it on the track as the power that runs the locos. You can have several boosters on a system, each driving its own track section. You can have both regular or auto reversing boosters depending on your needs. Also called Power Booster, Power Station

Browsing: scanning sequentially through locomotive or accessory decoder addresses and statuses in you throttle. Browsing with the DT300 by turning the throttle knobs or using the Y+ or N- Keys.

c: closed indicates that the turnout is in the straight through position, set for the mainline. For op switch set ups, consult your manual for the meaning of c & t.

Cab: See Throttle.

Command Station: Most systems have one Command Station that generates the DCC packets that send commands to the decoders. The command station also produces Rail Sync so that all the devices on your LocoNet work together.

Common (Loco Status): a DCC locomotive that is not currently “in-use” by a throttle connected to LocoNet but is still being refreshed by the command station. A loco with a status of “common” is selectable by any throttle on LocoNet.

Common Rail Wiring: A wiring system in which one side of all the track power supplies are connected. The common rail concept simplified block wiring in conventional DC systems, but is not recommended for DCC wiring. (see Direct Home Wiring).

Compatibility: the ability of equipment made by various DCC companies to operate together on the same layout. DCC compatibility extends to decoders and boosters but not to throttles, command stations, system architecture and advanced features that are not DCC related.

Configuration Register(CV29): this special CV controls several different decoder characteristics including:

1. Whether the decoder uses standard 14 speed step mode or advanced 28/128 speed step mode
2. Whether or not the decoder will automatically convert to DC operation when no DCC signal is present
3. In the case of Digitrax FX decoders, the normal direction of locomotive travel
4. Whether the decoder uses loadable speed tables and
5. Whether the decoder uses the 2 digit address or the 4 digit address.

Configuration Variables (CVs): these are special storage locations or “pigeonholes” in your decoders. By programming values into various CVs, you can control each decoder’s performance characteristics. CVs store information like the decoder’s address, start voltage, mid-point voltage, loadable speed tables and many more. Once you have programmed these characteristics, the decoders “remember” them until you change them again. The NMRA Standard and RPs define the usage of many CVs while others are defined by DCC manufacturers.

Conformance Seal: issued by the NMRA after a product has passed the tests established and administered by NMRA volunteers to “prove” that a particular product follows exactly to the letter the Standards and RPs set up by the NMRA that pertain to that product. Conformance seals do not insure interoper-

ability or the quality of the products, only manufacturers provide warranties on the equipment they sell.

Consisting: linking more than one locomotive together to be controlled by a single throttle and or address. Also called multiple unit operation, MU'ing, multiple unit lash ups, etc.

Constant Brightness Lighting: because DCC runs with constant track voltage, locomotive lights stay on even when the loco is not moving, just like the prototype.

Conventional Loco: A locomotive operating on a DCC layout without a DCC decoder installed. Also called an Analog Loco.

DCC: Digital Command Control.

DC or Direct Current: An expression used to describe an electrical wave form in which the voltage remains more or less at a value above or below 0 volts. DC is used by most model railroad locomotives. Sometimes referred to as Analog.

Deceleration: The rate at which the decoder decreases from one speed step to the next in response to a new decrease speed command. Use CV04 to program the deceleration value for each decoder. This feature is used to simulate train momentum so that, just like the prototype, your model won't stop immediately when the brakes are applied.

Decoders, Mobile: the electronic device installed in each locomotive that receives the signal from the command station through the track, decodes it & tells the loco what to do. Mobile decoders can also include function control, speed stabilization, transponding and other features.

Decoders, Stationary (Accessory or turnout): the electronic device for the turnouts or other accessories that receives the signal from the command station through the track, decodes it & tells the turnout/accessory what to do.

Decoder Status: the Digitrax command station assigns each decoder a status based on whether it is new to the system, in-use on a throttle, common in the system and available for selection or idle. The decoder status determines how the system treats that address.

Direct Home Wiring: A wiring system in which the DCC booster powers each rail through an individual conductor or wire. Each booster is wired to its own power district and there is no common connection between boosters. Digitrax strongly recommends direct home wiring.

Direct Programming: A type of service mode programming.

Directional Lighting: loco lights can be set up to automatically change so that the forward lamp is lit when the loco is moving forward and the reverse lamp is lit when moving in reverse.

Dispatching: use your DT throttle to set up a loco or consist you want to be run by an operator on a UT1 or UT2 (Utility throttle) or a BT2 (Buddy throttle) and then using a couple of keystrokes, dispatch the loco from the DT throttle and acquire it on the Utility throttle or Buddy throttle.

EPF or Extended Packet Format: an extension of the baseline DCC format that allows us to use four digit addressing and other expanded decoder features. The extended packet format is part of the DCC industry standards followed by most DCC companies.

FN: Shorthand for Function

F0: Shorthand for Function 0. F0 is two functions in one. F0 Forward controls the white function lead and F0 Reverse controls the yellow function lead. Digitrax ships all decoders set up for automatically reversing head/tail lights using F0 Fwd and F0 Rev. These can be programmed to operate separately and be controlled by the operator if you do not want automatic operation.

F1/F5: F1 is usually used to operate the bell if sound is being used. F5 is a normal on/off function that can be accessed by pressing and holding the FN F0 Key (use this key as a "shift" key) and then pressing the F1/F5 Key

F2/F6: F2 is a special key set up to act as a momentary function key. When you press F2 the function will remain active for as long as you hold the key down. This momentary feature is important if you are using a whistle or horn. F2 can also be latched on if you are not using it for a horn. F6 is a normal on/off function that can be accessed by pressing and holding the FN F0 Key (use this key as a "shift" key) and then pressing the F2/F6 Key.

F3/F7 and F4/F8: these are regular on/off function keys. F3 & F4 can be turned on and off by pressing them after the FN F0 Key is pressed and you are in function mode. F7 & F8 can be accessed by pressing and holding the FN F0 Key (use this key as a "shift" key) and then pressing the F3/F7 or F4/F8 Key.

Fast clock: used by many operators during operating sessions to simulate prototypical operations. Traditionally, the fast clock is on the wall and is set up to run at a faster than normal time so that you can "get in a full day's work on the railroad in a fraction of the time."

Functions, Decoder: function leads are extra decoder wires that you can connect to any device on the loco that you want to control from the hand held or other input device such as a computer. These can be used for locomotive lighting, sound units, smoke units, and other locomotive animation tasks.

FX Functions: specially designed functions (available on Digitrax FX series decoders) that let you set up lights on your loco to simulate Mars lights, Gyras lights, ditch lights, rotating beacons, single or double pulse strobes, flashing lights, random firebox flicker and more. CVs 49-63 are used to set up these special light effects.

Idle (Loco Status): DCC locomotive that has been addressed by the system previously, is currently selectable by a throttle on LocoNet, and is not being refreshed.

In-Use (Loco Status): DCC locomotive that is currently selected on a throttle connected to LocoNet. An in-use loco is having its data refreshed by the command station and is not selectable by other throttles on LocoNet. The exception to this is if a throttle “steals” an in-use loco

L: Left throttle, Left reverse key, Left side of DT300 display

Loadable Speed Table: use CV65 through CV95 to enter a value for each discrete speed step in a 28 speed step curve. This feature allows you to customize a loco’s performance curve and makes speed matching of locomotives possible. With this feature you can limit the top speed of a loco. Once you have programmed CV65 through CV95 to set up the table, you will also need to set up CV29 to enable it. This allows you to enable and disable the table at will and to keep the table stored even when it is not in use. Digitrax FX & 4th generation decoders go one step further and give you 128 speed step resolution with loadable speed tables.

LocoNet: Digitrax’s powerful communications network especially designed for model railroad operation.

Mid-Point Voltage: the value programmed into CV06 specifies the voltage to apply to the motor at speed step 15 in a 28 step system and step 7 in a 14 speed step system. This allows you to make a quick adjustment to the motor voltage/speed curve without setting up a loadable speed table.

MU: Multiple unit operations. See Consisting.

N: No, use this key to respond to DT300 text messages.

New (Loco Status): DCC locomotive that has not been addressed by the system. A new loco is selectable by throttles on LocoNet and is not refreshed.

Operating Mode: 14 or 28/128 speed steps. See also, Speed Steps, Standard Mode, Advanced Mode & 128 Speed Step Mode.

Operations (OPS) Mode Programming: lets you program CVs in DCC locos equipped with EPF decoders while they are on the mainline. A typical use for ops mode programming would be to change the acceleration rate (CV03) or the deceleration rate (CV04) of your locos to simulate the weight and braking characteristics of the train to compensate for changing the number of cars and power units in the train.

Paged Programming: Digitrax preferred method of service mode programming.

Physical Register Programming: A primitive type of service mode programming. This method is limited to programming 2 digit address, acceleration, deceleration and start voltage.

Power Booster: See Booster

Power District and Power Sub-district: A power district is the power wiring, components and equipment attached to that wiring, driven by a single properly isolated booster. A power sub-district is a sub-division of a power district.

Power Station: See Booster

Power Supply: a transformer that provides power to the DCC system. The transformer is not usually included with the DCC system.

Programming: entering values into configuration variables (CVs) available in DCC decoders.

Purging: the process by which Digitrax command stations automatically release DCC locomotives from “in-use” to “common” when they are not selected on a throttle connected to LocoNet. This makes locos that have been “forgotten” by their operators available to be selected by other operators to prevent problems during an operating session.

PWM: Pulse Width Modulation.

R: Right throttle, Right reverse key, Right side of DT300 display.

Refreshed (Data): Digitrax command stations re-send data to decoders many times to be sure that the signal is not lost and that you have reliable operation. All in-use and common locos in the system will continue to be refreshed until they become idle.

Route: a group of turnouts and their specified positions that will be triggered by the activation of a single “TOP” switch address to a specified position.

Scaleable Speed Stabilization: a decoder that uses back EMF to maintain constant speed but can also buffer the speed changes to allow for optimal operation.

Select: To assign a decoder address to a throttle in the system so that the address can be controlled by that throttle.

Selectable: a DCC decoder is selectable when it is not currently in-use on another throttle.

Service Mode Programming: service mode programming information sent by the command station or programmer as a broadcast signal that goes out to all decoders on the track.

Slot Following: when more than one DT throttle has a single loco address selected, both DT throttles will have control of that address and both throttle displays will be updated with the same information. In other words, both operators will see what the other is doing.

Speed Stabilized Decoder: a decoder that will cause a locomotive to maintain the speed you set no matter what grade the loco encounters. It’s like “cruise control for your loco.” If speed stabilization is not scaleable, you can have the pushy pusher problem if you run consists.

Speed Steps: because DCC is a digital system, locomotive speeds are defined as discrete speed steps. This means that as motor voltage is increased, the speed of the locomotive increases in a straight line from stop to full speed with discrete speed values at each voltage.

Split field Motor: Another term for AC motor

Standard Mode (14 Speed Step Mode): the motor voltage/speed curve of the DCC loco from stop to full speed has 14 discrete speed steps. This means that speed control will be limited to just 14 steps. 14 speed step mode gives reasonably good speed control. Increasing to 28 speed step operation will give much better speed control and going to 128 speed step operation will give really excellent speed control. Standard mode is offered in most command stations

because there are many decoders on the market that are not capable of 28 or 128 step mode.

Start Voltage (V-start): the voltage added to the motor drive voltage at the first speed step. This adjustment allows you to trim the loco to compensate for its motor efficiency.

Status Editing Decoders: a DCC decoder’s status can be manually changed by a Digitrax command station at any time the decoder is selectable.

Stealing a Loco: overriding the in-use interlock and forcing the throttle to select an in-use loco. This can result in having two throttles logged on to and controlling one address. See also Slot Following.

t: thrown indicates that the turnout is set for the diverging route. For op switch set ups, consult your manual for the meaning of c & t.

Throttles: Throttles are input devices that tell the Command Station what you want the decoders to do. You can have many throttles on your system. The number is determined by the capabilities of the Command Station you are using. You can also use a computer to create “soft” throttles. Sometimes DCC throttles are also called “Cabs.”

TOP Locomotive: Digitrax calls the locomotive that other locomotives are consisted to, the TOP locomotive because it is not necessarily the lead loco in the consist. The TOP locomotive address controls the speed & direction of all locomotives consisted to it.

Transponding: The use of transponders installed in rolling stock and transponder detectors installed in the layout to allow the system to determine the location of a particular piece of rolling stock on the layout. Other information about the rolling stock such as speed, direction, etc. can also be determined. Transponding is useful for automation of staging yards, dispatching and for realistic sound systems.

Universal Consisting: the command station handles all consist information and lets you consist locos with any DCC decoder as well as analog locos. The locos can be added to and deleted from the consist in any orientation head to head or tail to tail.

Y: Yes use this key to answer questions in the DT300 text message display.

Zero-Stretching: incorporates a time period between packets to give you an effective DC offset between the two rails. This allows you to control a DC locomotive along with the DCC locomotives on a DCC system.

30.0 FCC Information

Radio or TV Interference: (this information is MANDATED by the FCC)

This equipment has been tested and found to comply with the limits for a Class B digital device, pursuant to part 15 of the FCC rules. These limits are designed to provide reasonable protection against harmful interference in a residential environment. This equipment generates, uses and can radiate radio frequency energy and, if not installed and used in accordance with the instruction manual, may cause harmful interference to radio communications. However, there is no guarantee that interference will not occur in a particular installation. If this equipment does cause harmful interference to radio or television reception, which can be determined by turning the equipment off and on, the user is encouraged to try to correct the interference by one or more of the following measures:

- Reorient or relocate the receiving antenna.
- Increase the separation between the equipment and the receiver.
- Connect the equipment into an outlet on a circuit different from that to which the receiver is connected.
- Consult the dealer or an experienced radio/TV technician for help.

Note that any modifications to the equipment not expressly approved by Digitrax voids the users authority to operate under and be in compliance with CFR 47 rules, as administered by the Federal Communication Commission. Digitrax believes any conscientiously installed equipment following guidelines in this manual would be unlikely to experience RFI problems.

The DT300R is certified for “unlicensed” operations within the United States by the US FCC and has the identifier: FCC ID: LV3RF1 or other as displayed on the unit case. Canadian ID for DT300R is 3015102960. See unit case for certification identifiers from other countries.

The UR91 is certified for “unlicensed” operations within the United States by the US FCC and has the identifier: FCC ID: LV3UR91 or other as displayed on the unit case. Canadian ID for UR91 is 30151002940A. See unit case for certification identifiers from other countries.

Important Note: The DT300R is certified by the FCC and by Industry Canada using a 12” LocoNet cable only. Any modification to the cable may void the certification. For convenience an extension cord may be attached with a 6 pin adapter for tethered use only.

For Canadian Users:

“This digital apparatus does not exceed the Class B limits for Radio noise emission from digital apparatus set out in the Radio Interference Regulation or the Canadian Department of Communications.”

Le present appareil numerique n emet pas de bruits radio-electriques depassant les limites applicables aux appareils numeriques de la classe B prescrites dans le Reglement sur le brouillage radioelectrique edicte par le ministere des Communications du Canada.

31.0 Warranty and Repair Information

Digitrax gives a one year guarantee against manufacturing defects on DT300/R and DCS100. These units are not user serviceable (opening the case voids your warranty). If a defect occurs, return the unit to us for service. We will repair or replace these units at our discretion at no charge to you for one year from purchase date. This warranty excludes damage due to abuse, such as failure to properly protect against input over current with a fuse or circuit breaker or applying excessive input voltage to the unit. We will make any repair needed because of physical damage or electrical abuse at fair and reasonable rates.

Decoders- Digitrax carefully tests every decoder we ship to be sure that you receive reliable products. Because we want you to be comfortable installing your own decoders, we outline a decoder test procedure that you can perform so that you can be sure your decoder works before you begin installing it in your locomotive. If, within 60 days of purchase, your decoder fails to pass the decoder test procedure outlined in the instructions, we will replace it free of charge to you. Because we can’t control the actual decoder installation we can’t cover your decoder once you have tested it and started the installation. In the event that you somehow manage to “blow-up” one of these little guys, we will repair or replace it for a nominal fee (call for the current amount) if you return the decoder to us.

Do not remove the shrink-wrap protective sleeves from Digitrax decoders or open the Command Stations or other products. None of the units have user serviceable parts, and opening them will void ALL warranty protection. If you are returning a decoder that failed the test procedure, all wires must be their original lengths. Do not cut any wires or install any units until you are sure they have passed the Decoder Test Procedure detailed in the Decoder Manual. Please don’t return anything to Digitrax without calling and getting return instructions.

Please call tech support at (770) 441-7992 before you send anything to us for service so that we can try and resolve the problem by phone if possible. All warranties on Digitrax products are limited to refund of purchase price or repair or replacement of Digitrax products at the sole discretion of Digitrax. In the event that Digitrax products are not installed or used in accordance with the manufacturer’s specifications, any and all warranties either expressed or implied are void. Except to the extent expressly stated in this section, there are no warranties, express or implied, including but not limited to any warranties of merchantability or fitness for a particular purpose.

Digitrax, Inc. reserves the right to make changes in design and specifications, and/or to make additions or improvements in its products without imposing any obligations upon itself to install these changes, additions or improvements on products previously manufactured.

INDEX

2 digit addressing 50, 66, 116
4 digit addressing 50, 66, 116

A

acceleration 56, 71, 87, 117, 123
Advanced Consisting 59
Analog Operation 27, 58, 66, 117, 120, 125
automatic reversing 20, 26, 28

B

ballistic tracking 41, 48, 92, 97
Bar Graph 44, 51, 52, 54
basic consisting 58
battery 39, 89, 93, 94, 95, 98, 103

C

c 48, 102
cascaded routes 82
Clean Track 86
closed 48, 76, 78, 118
common 59, 75, 119
common rail wiring 22, 119
configuration variables 64, 67, 119, 123
Connect the DB150 to the track & transformer 8
Connect Your Layout To The Empire Builder II 10
Consist 58, 59, 61, 62, 63, 92, 117, 121
Customizing Your DT300 95

D

DCC Address Ranges & Display 50
DCS100 Option Switch Setu 102
deceleration 54, 56, 71, 120
decoder status 44, 76, 98, 120
Decoder Won't Respond 86
direct home wiring 22, 119, 120
Direct mode 65
direction 11, 42, 47, 55

dispatching addresses 63, 85

E

edit routes 82
empty 84
event driven network 19

F

fast clock 79, 80, 90, 97, 99
FCC Information 126
feeder wires 23
FN F0 Key 47
functions 45, 47, 51, 56, 121, 122

G

Global STOP 55, 97
Glossary 116
ground 34

H

heat dissipation 34

I

infrared 48, 107
infrared operation 39
Installing Digitrax On Your Layout 22
in-use 75

K

key & knob clicks 97
keyboard lock 93

L

L & R Reverse Keys 47
LCD backlight 98
Lo (Loco) Mode 49
Local STOP 54, 97
Loco Icon 42
LocoNet 6, 18, 24, 29, 119
LocoNet Cables 29

LocoNet ID 90, 91
LocoNet jacks 107
LT-1 29, 32, 86, 111

M

MODE 8
Mode Indicator 43
MODE Key 47
multi-format operation 114
Multiple Unit Operations 58

N

N - Key 48
nested route 81
network speed 19
Non-Digitrax decoder 77
normal walkaround operation 39

O

OFF LINE 35
ops mode programming 26, 65
option settings, DT300 96
over temperature 35

P

Paged programming mode 65
Physical register mode 65
polled bus 19
power districts 23, 24, 28, 33, 64, 120
POWER IN 8
power on indicator 34
power save 90
power sub-districts 24
programming CV's other than addresses 67
programming decoder addresses 64
programming mode 65
programming track 25, 26, 64
programming, ops mode 92
purge 75

Q

quarter trick 24, 32, 86
Quick Start 7

R

radio 107
radio frequency 102
radio operation 39
Rail A & B 10, 34
recall 41, 52, 99
Recommended wire sizes 22
Releasing a Locomotive 92
releasing an address 62, 85
Resuming your session 17
reverse 41
reversing section 26, 28, 118
route entry 84
routes 81
RUN 8

S

SCALE 8
SEL Key 47
select a loco to run 47, 50
Selecting An Address On A Throttle 50
semaphores 46
service mode programming 25
Shut Down and Resume Procedures 85
Shutting Down the System 17
signaling 46
Slot Following 53
slot=max 53, 87
slots 74
smoke icon 42
speed control 54
status editing a decoder 77, 125
Stealing 52, 125
STOP key 46
stop, global emergency 97
stop, local emergency 97
straight line tracking 41, 48, 97
switch mode 78
system architecture 18

T

- t 48, 103
- testing LocoNet cables 29
- tetherless 46, 89
- tetherless operation mode 98
- tetherless release 92
- Text Area 44
- throttle default decoder operation 98
- throttle ID 102
- Throttle Knobs 40
- throttle type 102
- thrown 48
- TOP 59
- TOP loco 61
- track power 48
- track power indicator-DT300 46
- TRACK STATUS 34
- track wiring 22
- transformers 33
- Troubleshooting 86
- Troubleshooting DB150 Shutdowns 35
- Troubleshooting Layout Wiring 31
- turnout control 48
- turnout operation 78
- typematic 48

U

- UniVersal Consisting 58
- UP3 Universal Panel 8
- UR90 110
- UR91 110

W

- Warranty and Repair 127

Y

- Y + Key 48

Z

- zero Speed 54